

catálogo de sistema

Q EXPANSION 36

SISTEMA CORREDERA MINIMALISTA CON
ROTURA DE PUENTE TÉRMICO

rotura de puente térmico mediante varillas de poliamida de 6.6 de 16 y 24 mm

Q systems®

aluminio

INDICE

1_ Características técnicas de la serie

2_ Accesorios y juntas

3_ Relación de perfiles

4_ Perfiles

5_ Nudos sistema QEXP-C ESTÁNDAR

6_ Nudos sistema QEXP-C POCKET

7_ Nudos sistema QEXP-C CORNER

8_ Nudos sistema QEXP-C MOSQUITO

9_ Nudos sistema QEXP-G GUILLOTINA

10_ Nudos sistema QEXP-P PIVOT

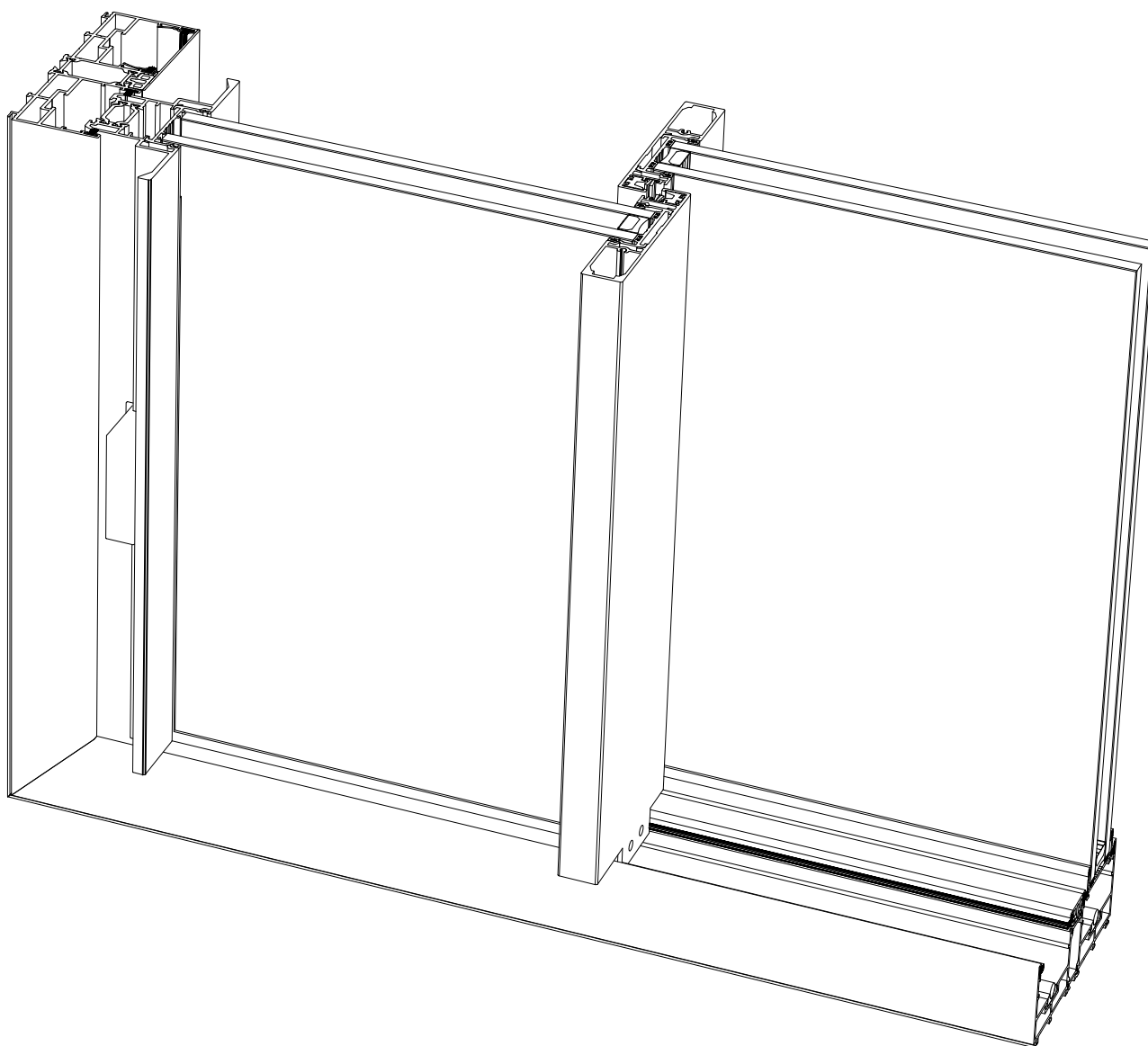

Sistema minimalista corredera con rotura térmica
(Minimalist sliding system with thermal break)
(Système coulissant minimaliste avec rupture thermique)

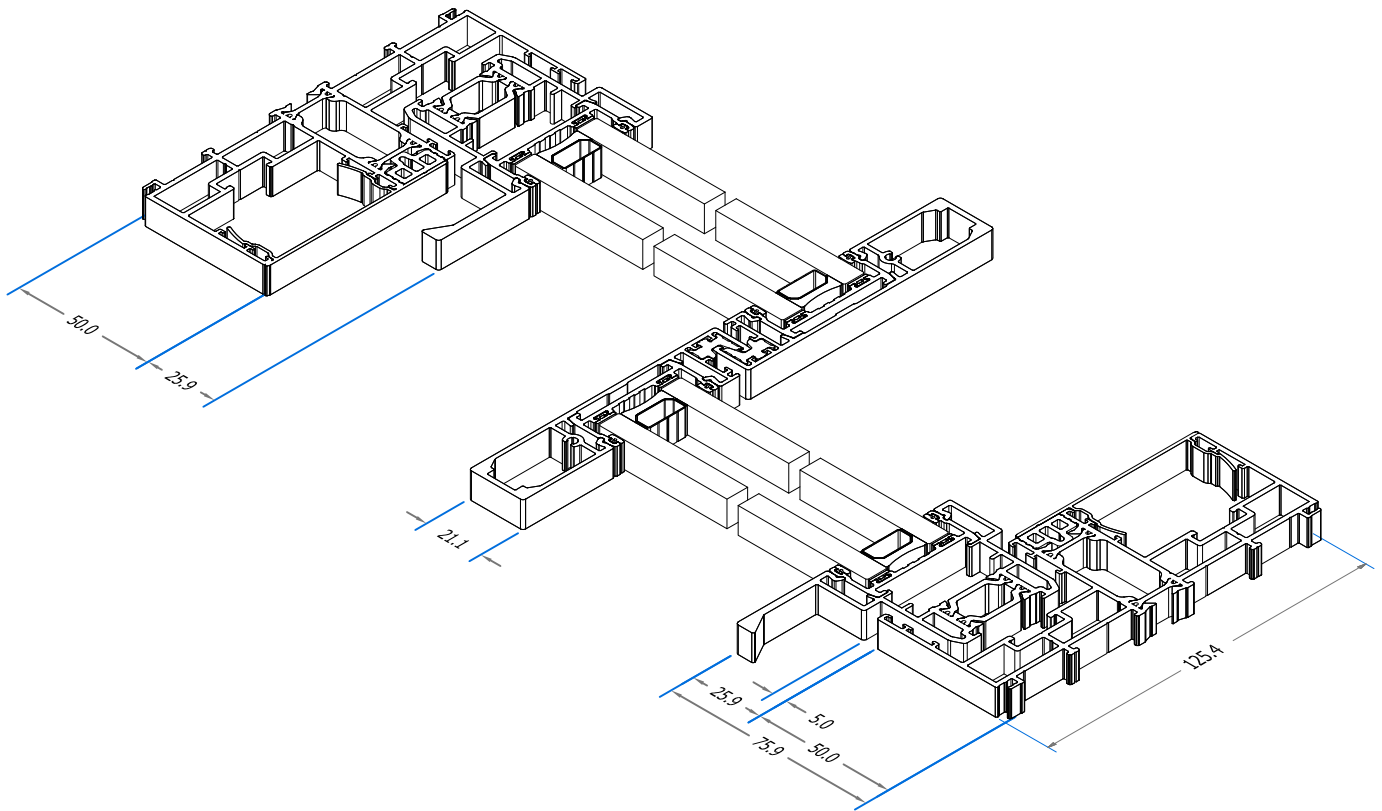

DESCRITIVO (DESCRIPTION)

ES # El sistema minimalista **EXP**ansion y sus soluciones han sido diseñados para un nivel de calidad, versatilidad y fiabilidad hasta ahora no alcanzado.

EN # The **EXP**ansion minimalist system and their solutions has designed to a level of quality, versatility and reliability until now unattainable.

FR # Le système minimaliste **EXP**ansion et ses solutions ont été conçues pour un niveau de qualité, polyvalence et fiabilité jusqu'à présent non atteint.

ES # La versatilidad de un sistema corredera, combinada con una opción multicarril y asociado a su elevada capacidad mecánica con la posibilidad de aperturas motorizadas secuenciales de varias hojas, permite al sistema **QEXP-C** estándar cumplir con todas exigencias técnicas y estéticas impuestas por los requerimientos arquitectónicos.

EN # The versatility of a sliding system merge with a multi-rail option and associating the high mechanical capacity to the possibility of sequential motorized openings of several sheets, allows the **QEXP-C** Standard system to meet all technical and aesthetics demands imposed by architectural requirements.

FR # La polyvalence d'un système coulissant en conjonction avec l'option multicarril et impliquant une grande capacité mécanique à la possibilité d'ouvertures motorisées séquentielles de plusieurs vantaux, permet le système standard **QEXP-C** de faire face à toutes les exigences techniques et esthétiques imposées par les exigences d'architecture.

EL DISEÑO
(THE DESIGN)
(LE DESIGN)

LA RESISTENCIA ESTRUCTURAL
(A STRUCTURAL RESISTENCE)
(A RÉSISTENCE STRUCTURELLE)

LOS ELEVADOS RENDIMIENTOS
(THE HIGH PERFORMANCES)
(LA HAUTE PERFORMANCE)

aluminio

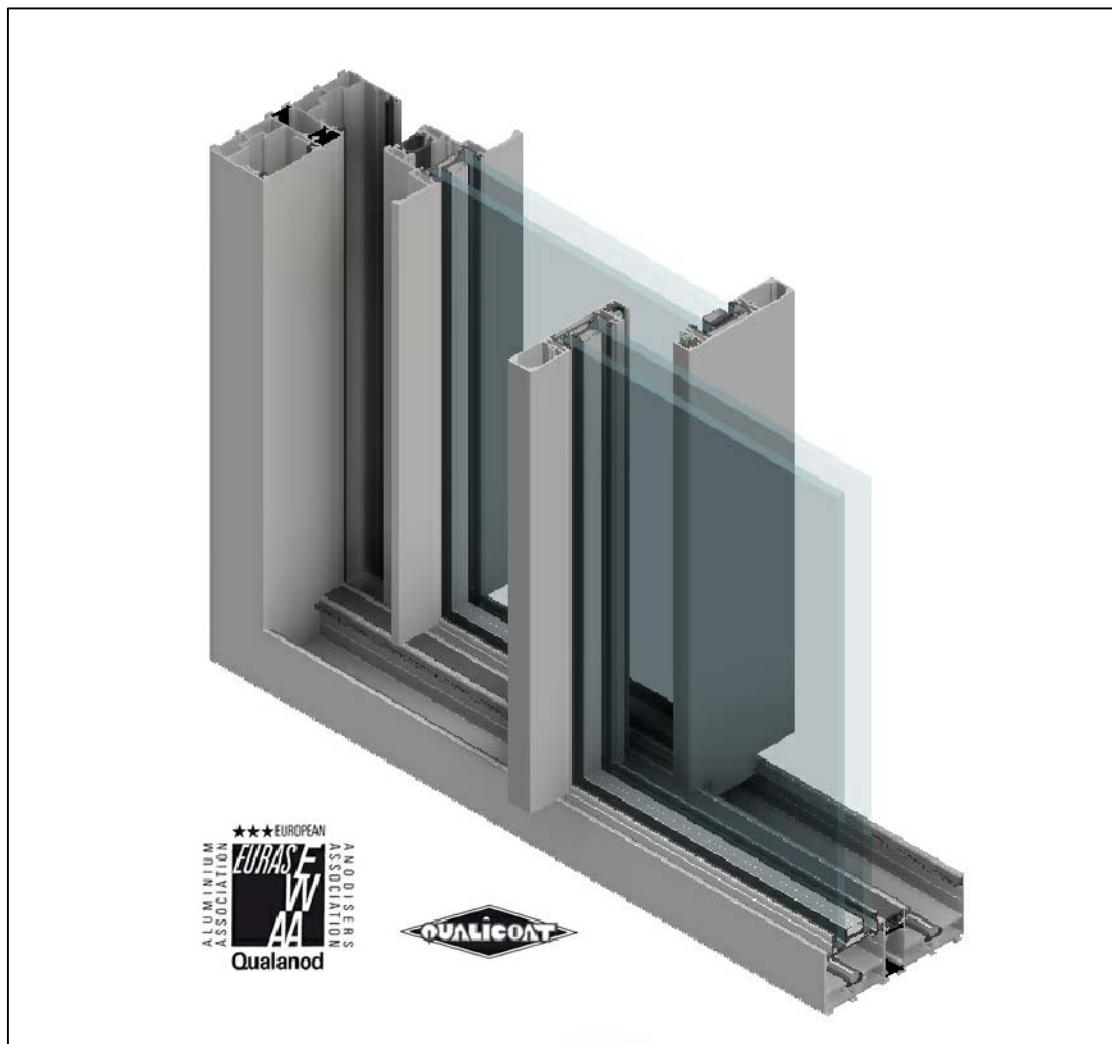



LINEAS PRESENTATION LINES LIGNES DE PRÉSENTATION	rectas straight droite		
SECCIONES SECTIONS SECTIONS	1 CARRIL	2 CARRILES	3 CARRILES
marcos fijos fixed frames cadre dormant	55 mm	125 mm	196 mm
hojas móviles mobile frames cadre ouvrant	54 mm 83 mm 112 mm		
hojas centrales middle profiles centres	66 mm 96 mm		
vista lateral lateral sight vue latérale	25 mm		
vista central central sight vue centrale	21 mm		
vista superior e inferior upper and lower sights vues supérieure et inférieure	0 mm		
ACRISTALAMIENTO FILLING REMPLISSAGE	32 mm 36mm (vidrios templados) (tempered glasses verres trempés)		
CORTES CUTS COUPES	45° 90°		
SELLADO INSULATION ÉTANCHÉITÉ	Juntas en EPDM EPDM joints joint en EPDM		
PESO MÁXIMO MAXIMUM WEIGHT POIDS MAXIMALE	600 Kg/hoja	leaf vantail	
ÁREA MÁXIMA MAXIMUM AREA AIRE MAXIMALE	12 m²/hoja	leaf vantail	
ALTURA MÁXIMA MAXIMUM HEIGHT HAUTEUR MAXIMALE	5000 mm / hoja móvil	leaf vantail	
ACABADOS FINISHES FINITIONS	Lacados Anodizados Bicolores powder coating anodizing bicolour laqué anodisé bicouleur		

aluminio

Peso máximo/hoja
(maximum weight/leaf)
(poids maximum/vantail)

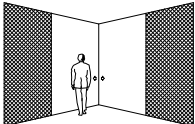

Altura máxima/hoja
(maximum height/leaf)
(hauteur maximale/vantail)

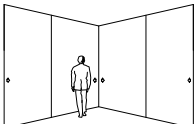
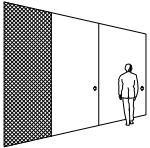
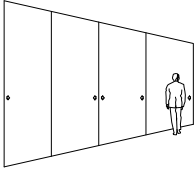
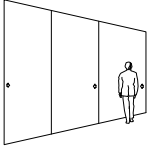
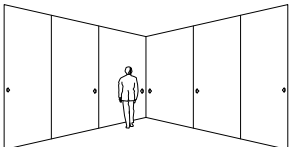
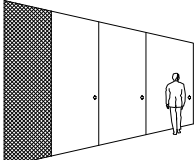
Área máxima/hoja
(maximum area/leaf)
(aire maximale/vantail)

		Peso máximo/hoja (maximum weight/leaf) (poids maximum/vantail)	Altura máxima/hoja (maximum height/leaf) (hauteur maximale/vantail)	Área máxima/hoja (maximum area/leaf) (aire maximale/vantail)
Monorail		600 Kg	5.00 m	12 m ²
		600 Kg	5.00 m	12 m ²
Birail		600 Kg	5.00 m	12 m ²
		600 Kg	5.00 m	12 m ²
		600 Kg	5.00 m	12 m ²
Trirail		600 Kg	5.00 m	12 m ²
		600 Kg	5.00 m	12 m ²
		600 Kg	5.00 m	12 m ²
		600 Kg	5.00 m	12 m ²

aluminio

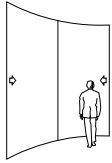
Peso máximo/hoja (maximum weight/leaf) (poids maximum/vantail)
Altura máxima/hoja (maximum height/leaf) (hauteur maximale/vantail)
Área máxima/hoja (maximum area/leaf) (aire maximale/vantail)

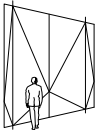
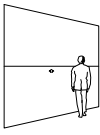
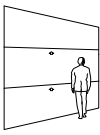
Curva		600 Kg	5.00 m	12 m ²
Pivot		500 Kg	5.00 m	10 m ²
		500 Kg	5.00 m	10 m ²
Guillotina		250 Kg	6 m ²
		250 Kg	6 m ²

aluminio

Marcado CE (EN 14351-1)
(CE MARKING)
(MARQUAGE CE)

Corredera de 2 hojas de 3,50 x 2,50m
Vidrio: 8 + 16 + 8 (templados)

2 leaves window 3.50 x 2.50m
Glass: 8 + 16 + 8 (tempered)

Fenêtre 2 vantaux 3.50 x 2.50m
Verre: 8 + 16 + 8 (trempé)

Permeabilidad al AIRE
AIR Permeability | Permeabilité à l'AIR

Estanquidad al AGUA
WATER Tightness | Étanchéité à l'EAU

Resistencia al VIENTO
WIND Resistance | Résistance au VENT

Transmitancia térmica (Thermal transmittance) (Transmission thermique)	Aislamiento acústico (Acoustic insulation) (ISOLATION ACOUSTIQUE)	Permeabilidad al aire (Air permeability) (Permeabilité à l'AIR)	Estanquidad al agua (Water tightness) (Étanchéité à l'EAU)	Resistencia al viento (Wind resistance) (Résistance au VENT)
1,0 - 1,7 (W/m²K) (UNE-ISO 13947:2005)	Hasta (up to) 41dB (NP EN 14351-1:2008 - ANEXO B)	Clase 4(Class 4) (EN 12207:2000)	Clase 7A(Class 7A) (EN 12208:2000)	Clase B4(Class B4) (EN 12210:2000)

Isotermas

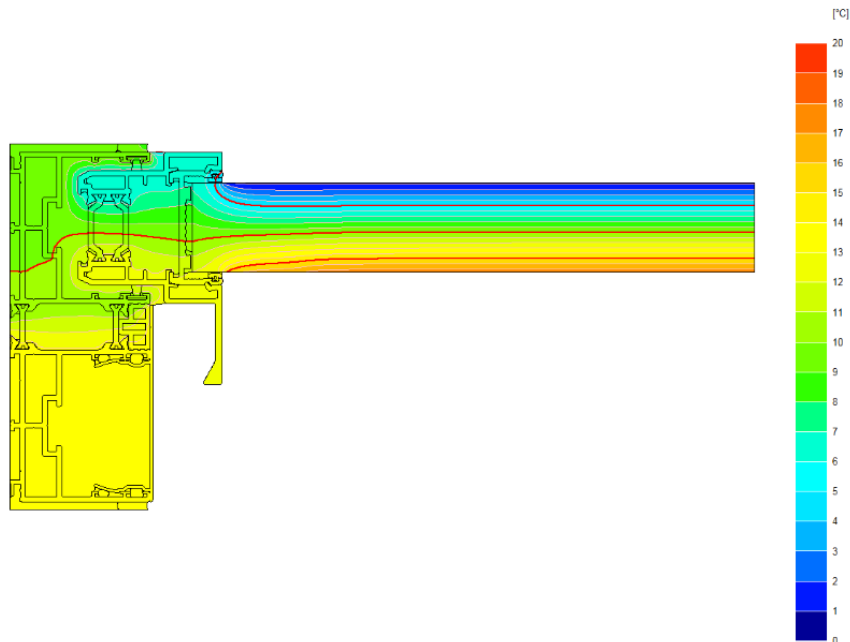

Sistema Q-EXPansión 36

Sistema corredera minimalista con RPT de 125 mm.

Características del sistema

Sistemas minimalista con rotura térmica y de alto rendimiento térmico y acústico.
El sistema Q-EXPansión 36 permite la ejecución de tres aperturas diferentes:

- Q-EXP/C con apertura corredera minimalista con hojas de hasta 600 kilos.
- Q-EXP/P con apertura pivotante con hojas de hasta 500 kilos.
- Q-EXP/G con apertura corredera guillotina con hojas de hasta 250 kilos por hoja.

Los sistemas Q-EXPansión 36 permiten la colocación de doble o triple acristalamiento de alto rendimiento con el fin de cumplir con los requisitos más exigentes en aislamiento térmico y acústico.

Perfiles de aluminio

Perfiles de aluminio extruidos en aleación 6063 según UNE 38337 o aleación 6060 según UNE 38350 y tratamiento T5.

Rotura térmica obtenida mediante la inserción de varillas de poliamida 6.6 reforzada con un 25% de fibra de vidrio de TECHNOFORM de 16 mm en marcos y de 24 mm en hojas.

Espesor medio de perfiles de aluminio de 1,8 mm.

Marcos

Marco de un carril con sección de 55 mm o de dos carriles con sección de 125 mm o de tres carriles con sección de 196 mm.

Marcos ensamblados con escuadra de fundición y de alineamiento en inox para la correcta unión de los ingletes.

Guía de deslizamiento inferior en acero inoxidable AISI 304 para evitar el desgaste de las piezas.

Hojas

Hojas móviles con sección de 54 mm.

Hojas ensambladas en corte recto mediante tornillos a piezas interiores en inox.

Estanqueidad asegurada mediante una doble barrera de doble felpa tipo Fin Seal o Trifin con laminas intermedias.

Vidrio aislante doble con sellado secundario mediante silicona neutra o estructural a la cámara TGI de 32 a 36 mm de espesor total, compuesto por tipologías de vidrio laminados, templados o termo-endurecidos. Montaje de vidrios mediante el sellado perimetral con silicona estructural tipo Dow Corning 791 negra o SG20 Black Dikasil.

Dimensiones y aperturas

Dimensión de hoja máxima hasta una altura de 5000 mm o una área máxima de 12 m².

Peso máximo de 600 kilos por hoja.

Tipologías de 1, 2, 3 4 o más hojas móviles o fijas, con posibilidad de apertura en esquina.

Posibilidades de apertura manual mediante cierre multipunto con micro-ventilación o motorización secuencial de varias hojas.

Clasificaciones

Sistema certificado por ITECONS laboratorio notificado nº 0305 para pruebas de ensayo inicial de tipo (ITT) según los requisitos definidos en la norma UNE-EN 14351-1:2006+A1:2011, "Ventanas y puertas. Norma de producto, características de prestación".

Categorías alcanzadas por el sistema QEXPansión 36 en tipología de corredera de dos hojas de 3500 x 2500 mm:

1. permeabilidad al aire: CLASE 4 (según EN 12207:2000)
2. estanqueidad al agua: CLASE 7A (según EN12208:2000)
3. resistencia al viento: CLASE B4 (según EN 12210:2000)

Coefficiente de transmisión térmica según norma UNE-EN ISO 10077-2:2012 para una ventana de 3500 x 2500 mm sobre distintas configuraciones de vidrio comprendidas entre los rangos de $U_g = 0,5$ a $3,5$ W/m²K

- $U_w = 1,0 - 1,7$ W/m²K

zonas de cumplimiento del CTE: **α A B C D E**

- en función de la transmitancia del vidrio

Coefficiente de atenuación acústica según norma UNE-EN 14351-1:2006+A1:2011 hasta 41 dB:

- acristalamiento 6/12/4 Rw (C; CTR) = 34 dB (-1; -4) dB
- acristalamiento 8/12/6 Rw (C; CTR) = 35 dB (-1; -4) dB
- acristalamiento 6/12/3+3 Rw (C; CTR) = 34 dB (-1; -4) dB

CORREDERA MINIMALISTA QSYSTEMS QEXPANSIÓN 36, con RPT

Ud. de balconera corredera minimalista de la serie QEXPANSIÓN 36 de QSYSTEMS, de 1, 2, 3 o más hojas con rotura de puente térmico mediante varillas aislantes de poliamida 6.6 reforzadas con 25 % de fibra de vidrio de 16 mm en marcos y de 24 mm en hojas, realizada con perfiles de aluminio extruido en aleación 6063 según UNE 38337 o aleación 6060 según UNE 38350 y tratamiento T5, con un espesor nominal medio de la pared de aluminio de 1,8 mm.

Aluminio acabado anodizado según la marca de calidad QUALANOD, con un espesor mínimo de (15-20-25) micras, color o aluminio acabado lacado según el sello de calidad QUALICOAT (espesor de la capa de pintura poliéster mínimo 60 micras) , color RAL.....

La balconera está compuesta por perfiles de marco tubular de módulo 55 mm de un carril, de 125 mm para dos carriles y de 196 mm para tres carriles, el ensamblaje se realiza a corte a inglete y la fijación mediante doble escuadra de bloqueo de fundición. Drenaje en el rail inferior por mecanización, con deflectores antireflujo.

Perfiles de hoja lateral tubular de módulo de 54, 83 o 112 mm con una vista lateral de 25 mm, con ensamble a corte recto mediante tornillos a piezas internas de fijación en inox.
Perfiles de cruce de módulo de 66 o 96 mm con una vista central de 21 mm, con ensamble a corte recto mediante tornillos a piezas internas de fijación en inox.

QEXPANSIÓN 36 esconde los perfiles horizontales superior e inferior y los montantes laterales de la hoja en el interior del perfil de marco, dejando sólo visible el cruce central de las hojas. El perfil de marco, tanto en vertical como en horizontal, interior y exteriormente, puede ser oculto tras el muro y trasdosado por el interior, lo que permite una vez instalada que sólo apreciemos el vidrio y el montante central de las hojas. Permite también encuentros a 90° sin montante fijo en la esquina (esquina abierta) , pudiendo combinar marcos de 1, 2 o tres carriles en cada lado.

QEXPANSIÓN 36 permite un peso máximo por hoja de hasta 600 kilos, con una altura máxima por hoja de 5 metros y una área máxima por hoja de 12 m², con posibilidad tanto de accionamiento manual como de aperturas motorizadas secuenciales de varias hojas.

La baja permeabilidad al aire y la estanquidad al agua se consiguen mediante una barrera de doble felpa en horizontal y vertical, además de con un drenaje de agua por la parte inferior del marco.

Acristalada con dobles o triples vidrios con cámara aislante TGI y sello de calidad, admitiendo espesores desde 32 hasta 36 mm máximo, permitiendo el uso de acristalamientos de seguridad. Los vidrios deben de ir sellados con silicona neutra o estructural y colocados con junta de EPDM calidad marina.

Clasificación de la carpintería: Permeabilidad al aire CLASE 4 (según EN 12207:2000) , estanquidad al agua CLASE 7A (según EN 12208:2000) y resistencia al viento CLASE B4 (según EN 12210:2000) , con un coeficiente de transmisión térmica de hueco $U_w = 1,0 - 1,7 \text{ W/m}^2\text{K}$ (según UNE EN ISO 13947:2005) y una atenuación acústica de hasta 41 dB.

La balconera estará colocada sobre premarco de aluminio anclado a la obra de fábrica, aislada con espuma de poliuretano y sellada al exterior con un cordón de silicona con sección mínima de 3x3 mm. Rematada con tapajuntas perimetral interior en perfil de aluminio con el mismo acabado que la ventana/balconera.

Todo ello según detalles de proyecto, totalmente acabada y rematada y con p.p. de medios auxiliares para la realización de la obra.

COEFICIENTES DE TRANSMISION TERMICA U_H (W/m²K) SEGUN EL CTE

$U_{H,v}$	BALCONERA 2 HOJAS									
	3,00 m ²	3,50 m ²	4,00 m ²	5,00 m ²	6,00 m ²	7,00 m ²	8,00 m ²	9,00 m ²	10,00 m ²	12,00 m ²
0,5	1,3	1,2	1,2	1,1	1,0	1,0	1,0	0,9	0,9	0,9
0,6	1,4	1,3	1,2	1,2	1,1	1,1	1,0	1,0	1,0	1,0
0,7	1,5	1,4	1,3	1,3	1,2	1,2	1,1	1,1	1,1	1,1
0,8	1,6	1,5	1,4	1,3	1,3	1,3	1,2	1,2	1,2	1,2
0,9	1,6	1,6	1,5	1,4	1,4	1,3	1,3	1,3	1,3	1,3
1,0	1,7	1,6	1,6	1,5	1,5	1,4	1,4	1,4	1,4	1,3
1,1	1,8	1,7	1,7	1,6	1,6	1,5	1,5	1,5	1,5	1,4
1,2	1,9	1,8	1,8	1,7	1,6	1,6	1,6	1,6	1,6	1,5
1,3	2,0	1,9	1,9	1,8	1,7	1,7	1,7	1,7	1,6	1,6
1,4	2,1	2,0	1,9	1,9	1,8	1,8	1,8	1,8	1,7	1,7
1,5	2,1	2,1	2,0	2,0	1,9	1,9	1,9	1,8	1,8	1,8
1,6	2,2	2,2	2,1	2,1	2,0	2,0	2,0	1,9	1,9	1,9
1,7	2,3	2,2	2,2	2,1	2,1	2,1	2,0	2,0	2,0	2,0
1,8	2,4	2,3	2,3	2,2	2,2	2,2	2,1	2,1	2,1	2,1
1,9	2,5	2,4	2,4	2,3	2,3	2,2	2,2	2,2	2,2	2,2
2,0	2,6	2,5	2,5	2,4	2,4	2,3	2,3	2,3	2,3	2,3
2,1	2,6	2,6	2,5	2,5	2,5	2,4	2,4	2,4	2,4	2,4
2,2	2,7	2,7	2,6	2,6	2,5	2,5	2,5	2,5	2,5	2,5
2,3	2,8	2,8	2,7	2,7	2,6	2,6	2,6	2,6	2,6	2,5
2,4	2,9	2,8	2,8	2,8	2,7	2,7	2,7	2,7	2,7	2,6
2,5	3,0	2,9	2,9	2,8	2,8	2,8	2,8	2,8	2,7	2,7
2,6	3,1	3,0	3,0	2,9	2,9	2,9	2,9	2,8	2,8	2,8
2,7	3,1	3,1	3,1	3,0	3,0	3,0	3,0	2,9	2,9	2,9
2,8	3,2	3,2	3,2	3,1	3,1	3,1	3,0	3,0	3,0	3,0

siendo,

U_H la transmitancia térmica de la ventana completa, en W/m²K
 $U_{H,v}$ la transmitancia térmica de la parte acristalada, en W/m²K

La transmitancia térmica es el flujo de calor (W), en régimen estacionario, dividido por el área (m²) y por la diferencia de temperatura (K) a cada lado de la ventana.

AISLAMIENTO ACUSTICO SEGUN UNE EN 14351-1:2006 ANEXO B

R _w (C;Ctr) de la unidad de vidrio aislante	R _w (C;Ctr) área total ventana ≤ 2,7 m ²	R _w (C;Ctr) 2,7 m ² ≤ área total ventana ≤ 3,6 m ²	R _w (C;Ctr) 3,6 m ² ≤ área total ventana ≤ 4,6 m ²	R _w (C;Ctr) área total ventana ≥ 4,6 m ²
27(C;-3)	25 (-1;-1)	24 (-1;-1)	23 (-1;-1)	22 (-1;-1)
28(C;-3)	26 (-1;-1)	25 (-1;-1)	24 (-1;-1)	23 (-1;-1)
28(C;-4)	26 (-1;-2)	25 (-1;-1)	24 (-1;-2)	23 (-1;-2)
29(C;-2)	27 (-1;-1)	26 (-1;-1)	25 (-1;-1)	24 (-1;-1)
29(C;-3)	27 (-1;-1)	26 (-1;-1)	25 (-1;-1)	24 (-1;-1)
29(C;-4)	27 (-1;-2)	26 (-1;-2)	25 (-1;-2)	24 (-1;-2)
29(C;-5)	27 (-1;-3)	26 (-1;-3)	25 (-1;-3)	24 (-1;-3)
30(C;-2)	28 (-1;-1)	27 (-1;-1)	26 (-1;-1)	25 (-1;-1)
30(C;-3)	28 (-1;-2)	27 (-1;-2)	26 (-1;-2)	25 (-1;-2)
30(C;-4)	28 (-1;-2)	27 (-1;-2)	26 (-1;-2)	25 (-1;-2)
30(C;-5)	28 (-1;-3)	27 (-1;-3)	26 (-1;-3)	25 (-1;-3)
32(C;-2)	29 (-1;-2)	28 (-1;-2)	27 (-1;-2)	26 (-1;-2)
32(C;-4)	29 (-1;-3)	28 (-1;-2)	27 (-1;-2)	26 (-1;-2)
32(C;-5)	29 (-1;-3)	28 (-1;-3)	27 (-1;-3)	26 (-1;-3)
34(C;-2)	29 (-1;-1)	28 (-1;-1)	27 (-1;-1)	26 (-1;-1)
34(C;-3)	29 (-1;-2)	28 (-1;-2)	27 (-1;-2)	26 (-1;-2)
36(C;-4)	30 (-1;-2)	29 (-1;-2)	28 (-1;-2)	27 (-1;-2)

Nota: el valor de aislamiento de la ventana, de acuerdo con el anexo B de la norma UNE EN 14351:2006+A1:2011, es independiente del valor C de la unidad de vidrio aislante (UVA)

aluminio

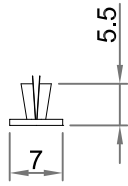

J2076 - Felpa 7x5,5 Q-Fin

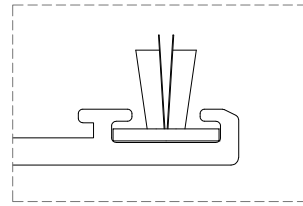

J2701 - Junta Marco

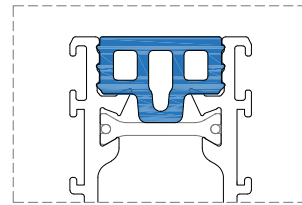

J2702 - Junta Cruce

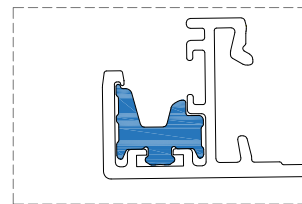

J2703 - Junta Acristalamiento

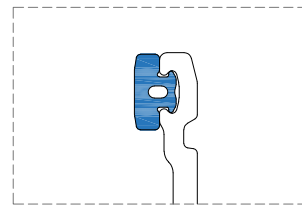

aluminio

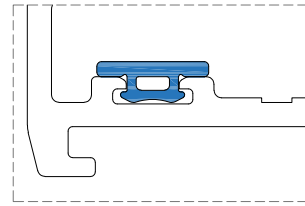

J2704 - Junta Interior Vidrio

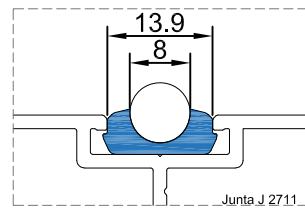
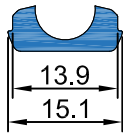

J2711 - Junta Guía Rodamiento

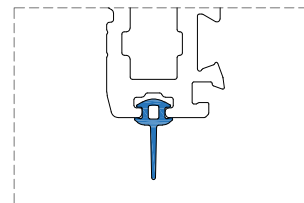

J2801 - Junta Batiente

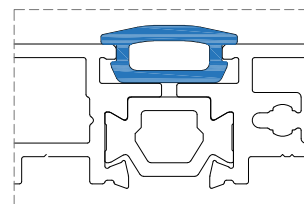

J2897 - Junta Cierre Marco

aluminio

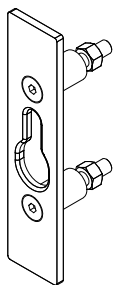

FE 001 - Placa Cierre EXP

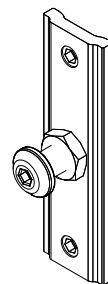

FE 005 - Contra Cierre inox

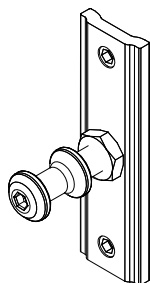

FE 006 - Contra Cierre micro ventilación inox



FE 007.1



FE 007.2

FE 007 - Placa Cierre EXP

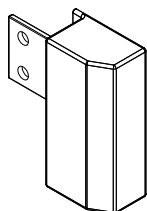

FE 009 - Cierre lateral

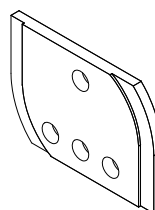

FE 010 - Presilla de fijación

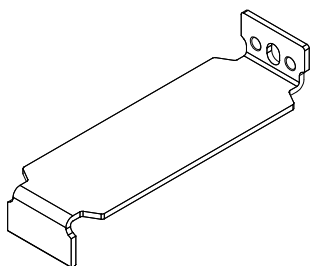

FE 011 - Fijador carro

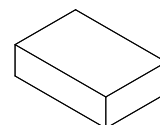

FE 093 - Cortaviento Poliamida EXP

aluminio

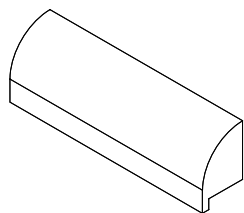

FE 014 - Tapa Salida de Aguas

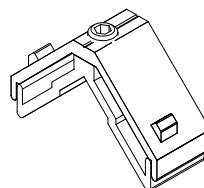

FE 015 - Escuadra 1411-5

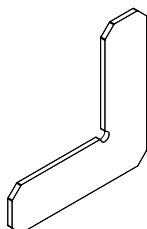

FE 016 - Escuadra alineamiento

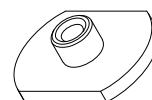

FE 021 - pieza especial roscada M4

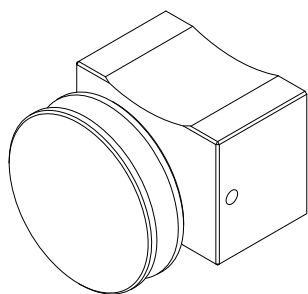

FE 025 - Cierre Lateral EXP

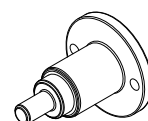

FE 026 - Muelle Anti-falsa maniobra EXP

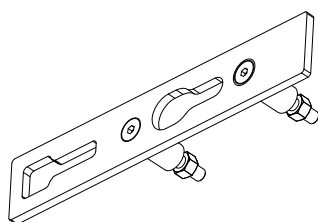

FE 027 - Placa Cierre Falsa maniobra EXP

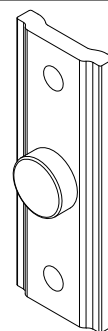

FE 028 - Batiente Falsa maniobra EXP

aluminio

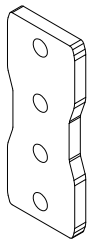

FE 077.1

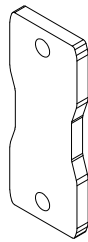

FE 077.2

FE 077 - Placa Cierre EXP

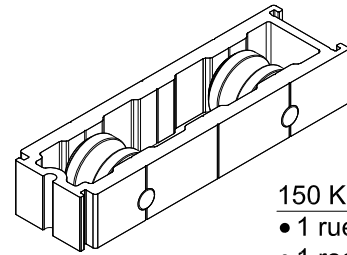

150 Kg/carro

- 1 ruedas
- 1 rodamientos

FE 101 - Carro EXP

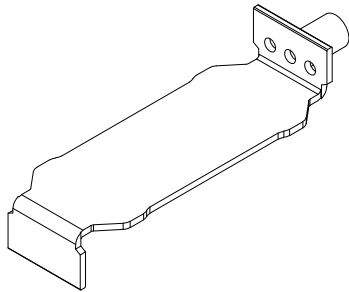

FE 111 - Fijador Lateral Carro

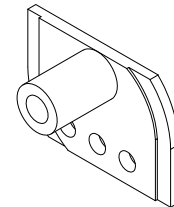

FE 112 - Presilla Lateral de Fijación

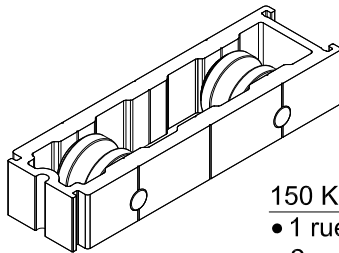

150 Kg/carro

- 1 ruedas
- 2 rodamientos

FE 121 - Carro Súper Deslizamiento EXP

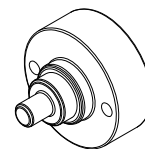

FE 126 Conjunto Anti-falsa Maniobra EXP

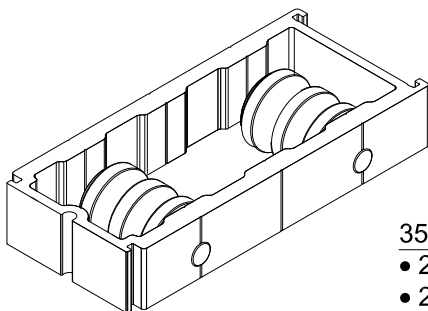

350Kg/carro

- 2 ruedas
- 2 rodamientos

FE 201 - Carro EXP (HR)

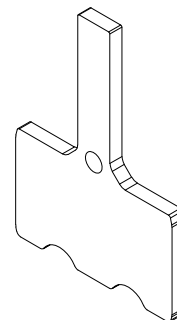

FE 202 - Tapa (HR)

aluminio

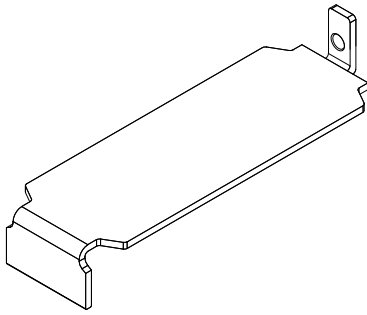

FE 211 - Fijador Carro (HR)

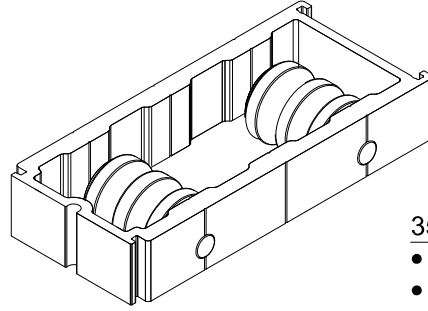

350 Kg/carro
 • 2 ruedas
 • 4 rodamientos

FE 221 - Carro Súper Deslizamiento EXP (HR)

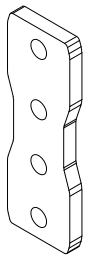

FE 507.1



FE 507.2

P/ EXP-070

FE 507 - Placa Cierre EXP

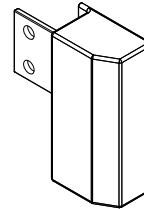

P/ EXP-070

FE 509 - Cierre Lateral

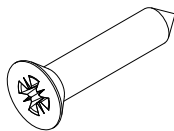

PF 014 Tornillo CQ 3,5x25 Inox

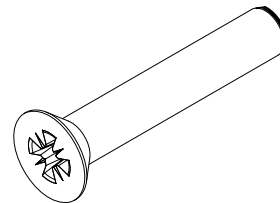

PF 201 Tornillo M5x35 Inox

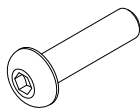

PF 204 Tornillo M4x20 Fijación Lateral Inferior (HR)



PF 206 Tuerca Baja M6 Inox

aluminio

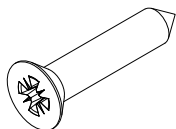

PF 212 Tornillo CQ 3,5x16 mm Inox p/ FE 026



PF 213 Tornillo M5x8 Inox Fijación FE 009

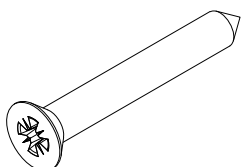

PF 214 Tornillo CQ 3,5x25 mm Inox p/ FE 013



PF 215 Perno M6x5 Inox para Testa



PF 216 Tornillo M5x5 Inox Fijación Central

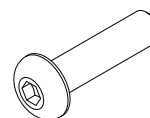

PF 217 Tornillo M5x20 Inox Fijación Lateral

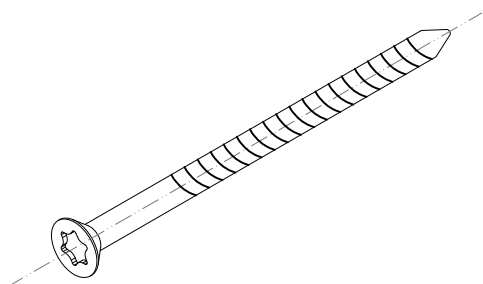

PF 219 Tornillo fijación AGL 5x80 mm Inox

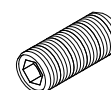

PF 236 Tornillo Fijación Inferior DIN 916 M4x8 (HR)

aluminio

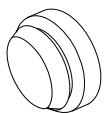

PL 010 - Tapón EXP

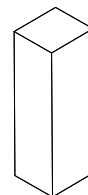

PL 040 - Amortiguador EXP

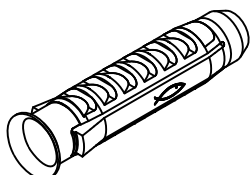

PL 041 Taco fijación 8x40 mm

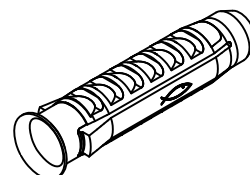

PL 042 Taco fijación 6x35 mm

aluminio



FE 034 - Comando emisor de mural "WIRELESS" 3 canales



FE 035 - Cerradura magnética



Apertura automática en caso de falta de energía

FE 036 - Cierre Electro-Pistón Tipo A (Fail Safe-Open)



Cierre automático en caso de falta de energía

FE 037 - Cierre Electro-Pistón Tipo B (Fail Secure-Closed)

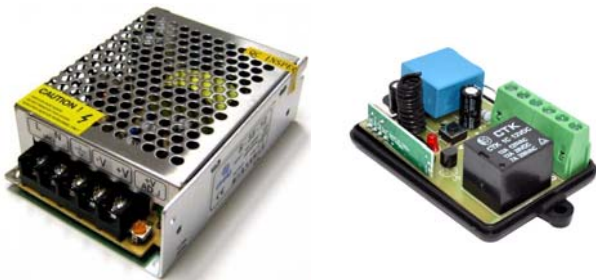

FE 038 - Unid. alimentación RF 12V P/ ELECTRO-IMAN

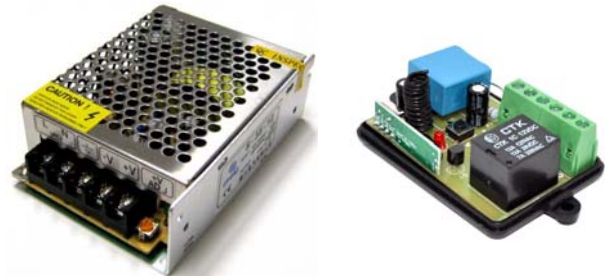

FE 039 - Unid. alimentación RF 12V P/ ELECTRO-PISTON



FE 040 - DIGIKEY de mural "WIRELESS"



FE 041 - Comando Mural 1Canal "WIRELESS"



FE 042 - Batería UPS 12V N°1

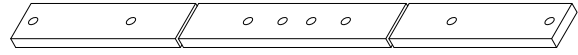

FE 043 - Barra Unión Cierre 20x5 EXP

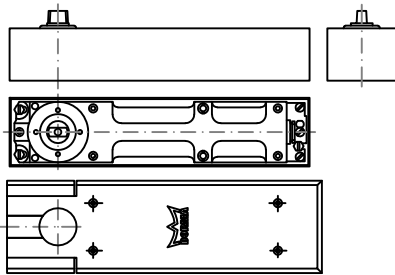

FE 044 - Muelle de Pavimento Pivot 300Kg

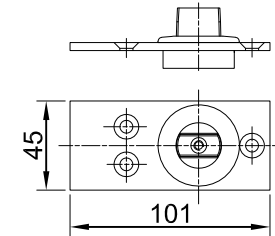

FE 045 - Eje de Pavimento Pivot 300Kg

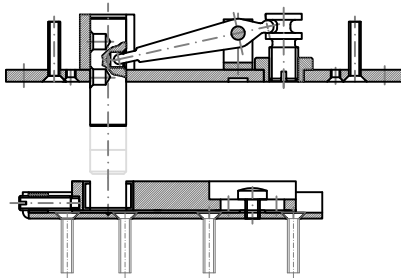

FE 046 - Conjunto Superior Pivot 300Kg

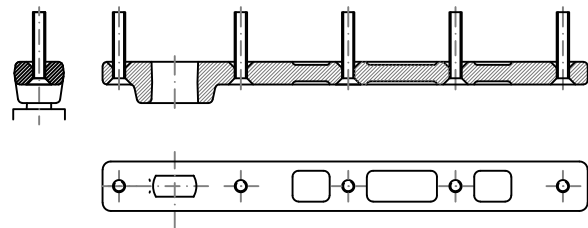

FE 047 - Brazo inferior Pivot 300Kg

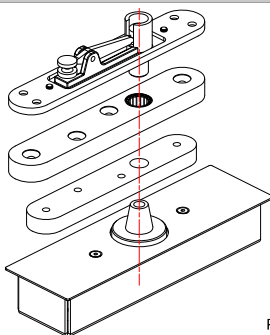

Peso máximo: 500Kg/hoja

FE 048 - Conjunto Pivot 500Kg

aluminio

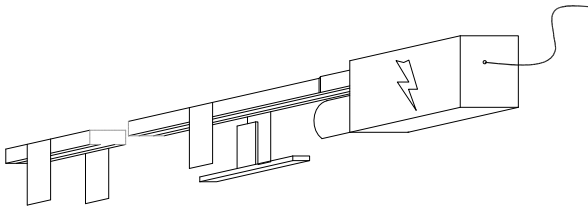

FE 051 - Sistema Motorización TIPO 1

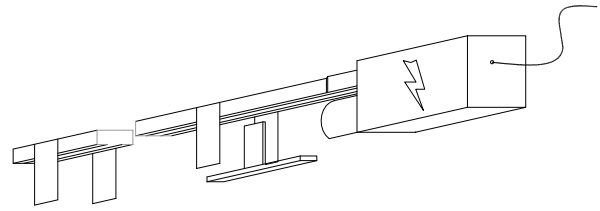

FE 052 - Sistema Motorización TIPO 2

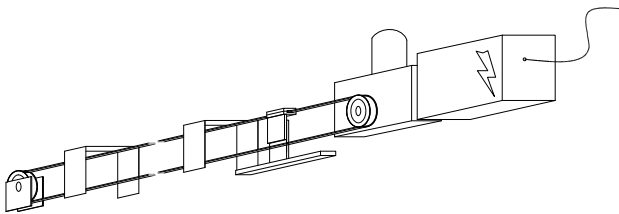

FE 053 - Sistema Motorización TIPO 3

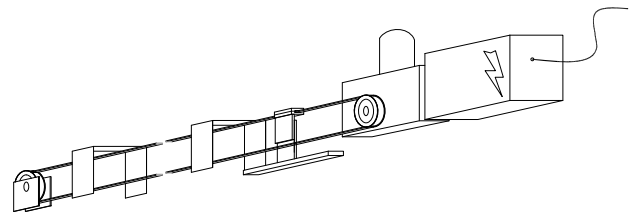

FE 054 - Sistema Motorización TIPO 4

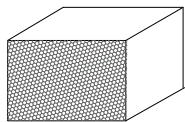

(esponja)

FE 060.1 - Cortaviento Lateral

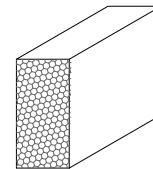

(esponja)

FE 060.2 - Cortaviento Lateral

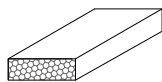

(esponja)

FE 061 - Cortaviento Central

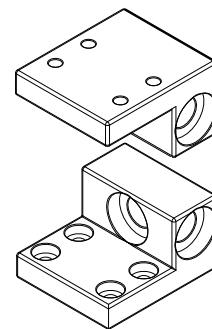

FE 070 - Conjunto Batiente Esquina 90° EXP

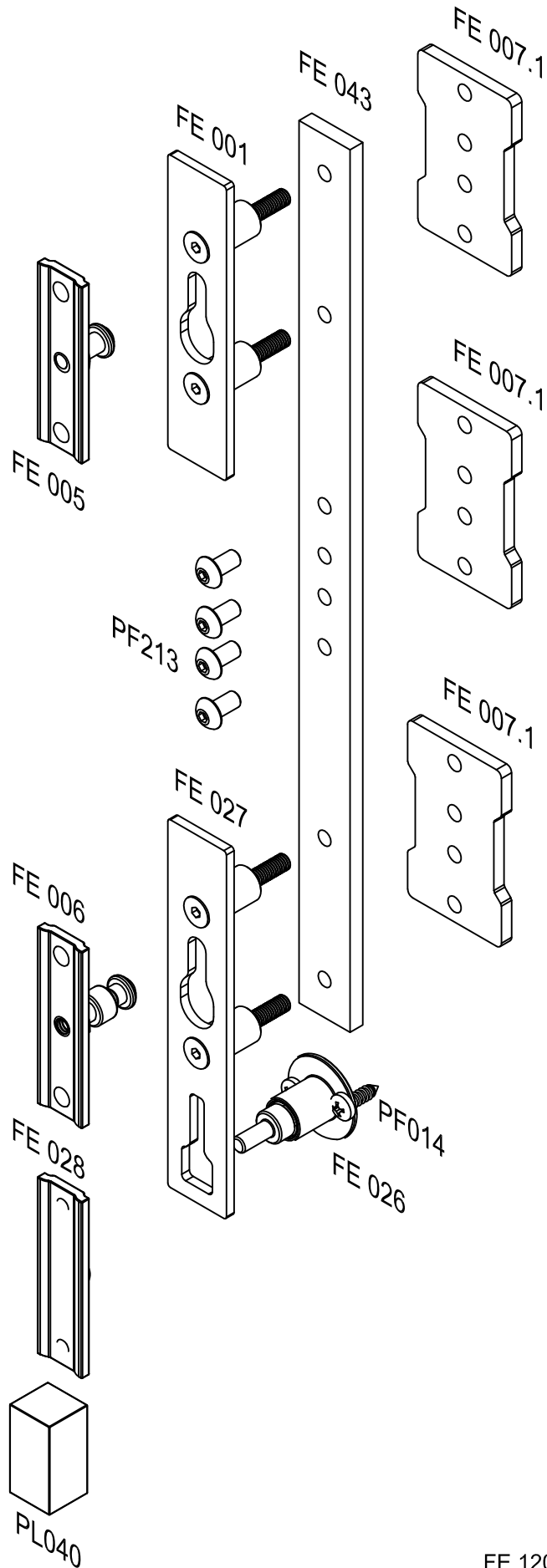

FE 1200 - KIT cierre - 2 puntos

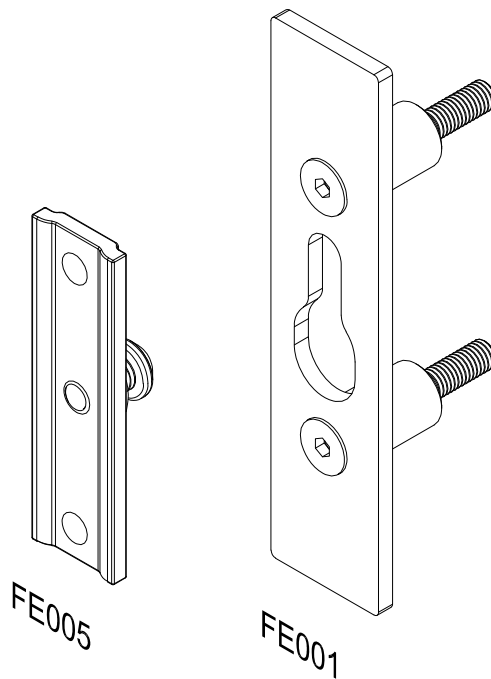

FE 1202 - KIT cierre - Punto extra

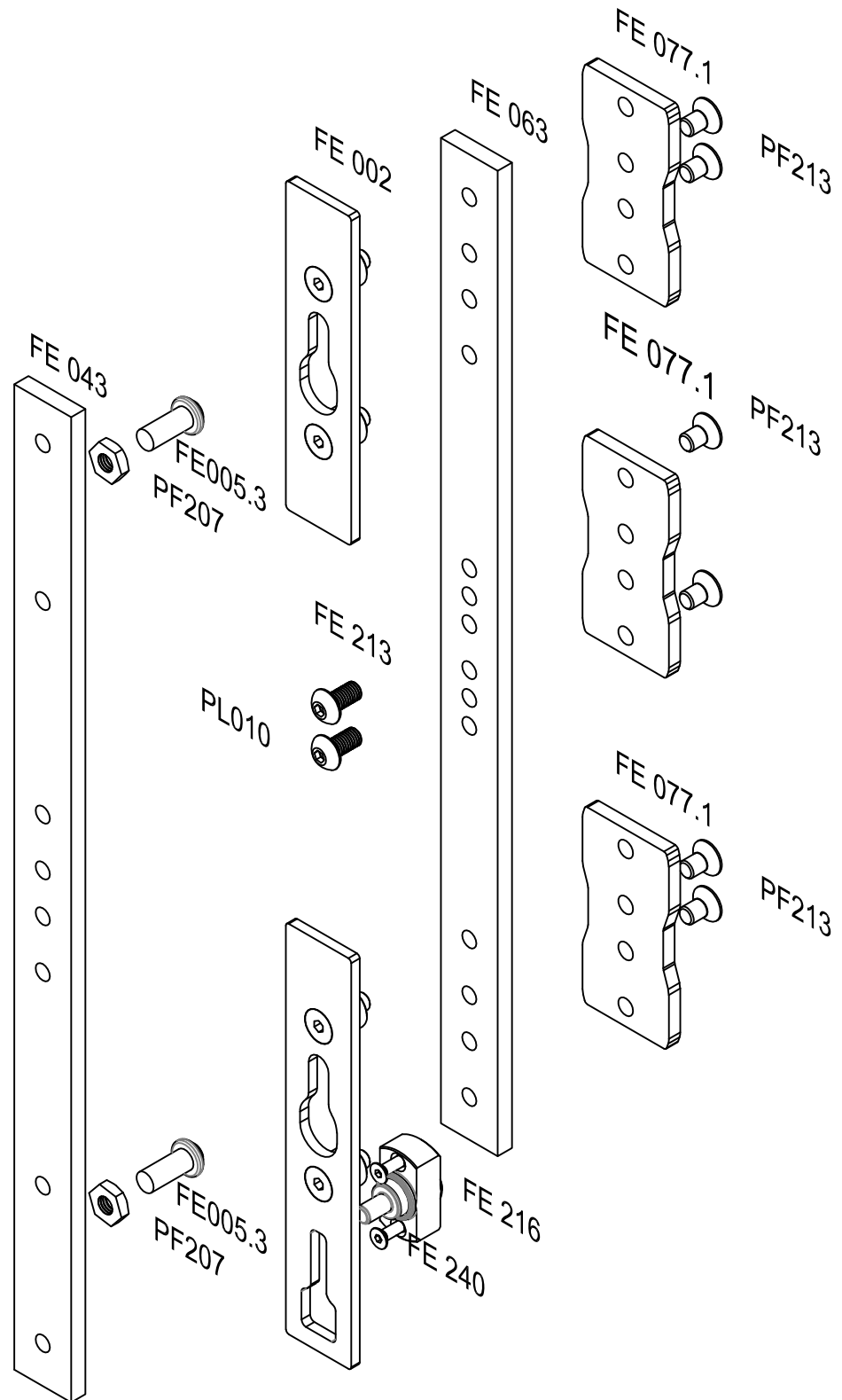

FE 1201 - KIT cierre central - 2 puntos

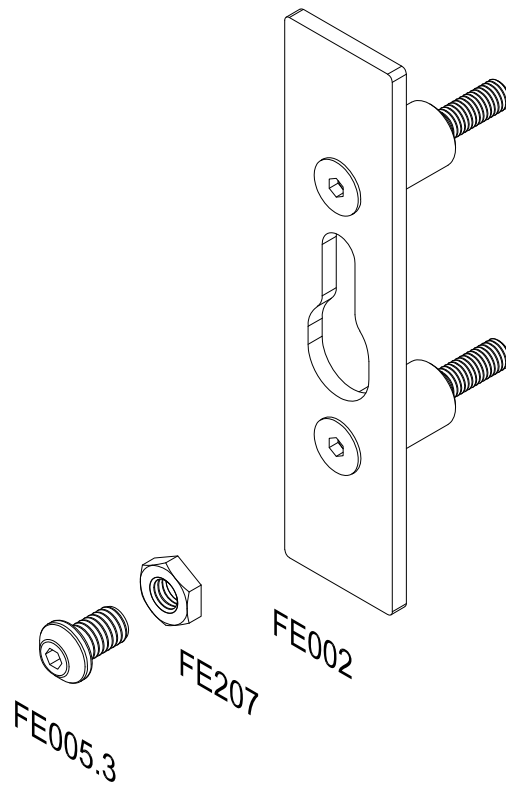

FE 1203 - KIT cierre central - Punto extra

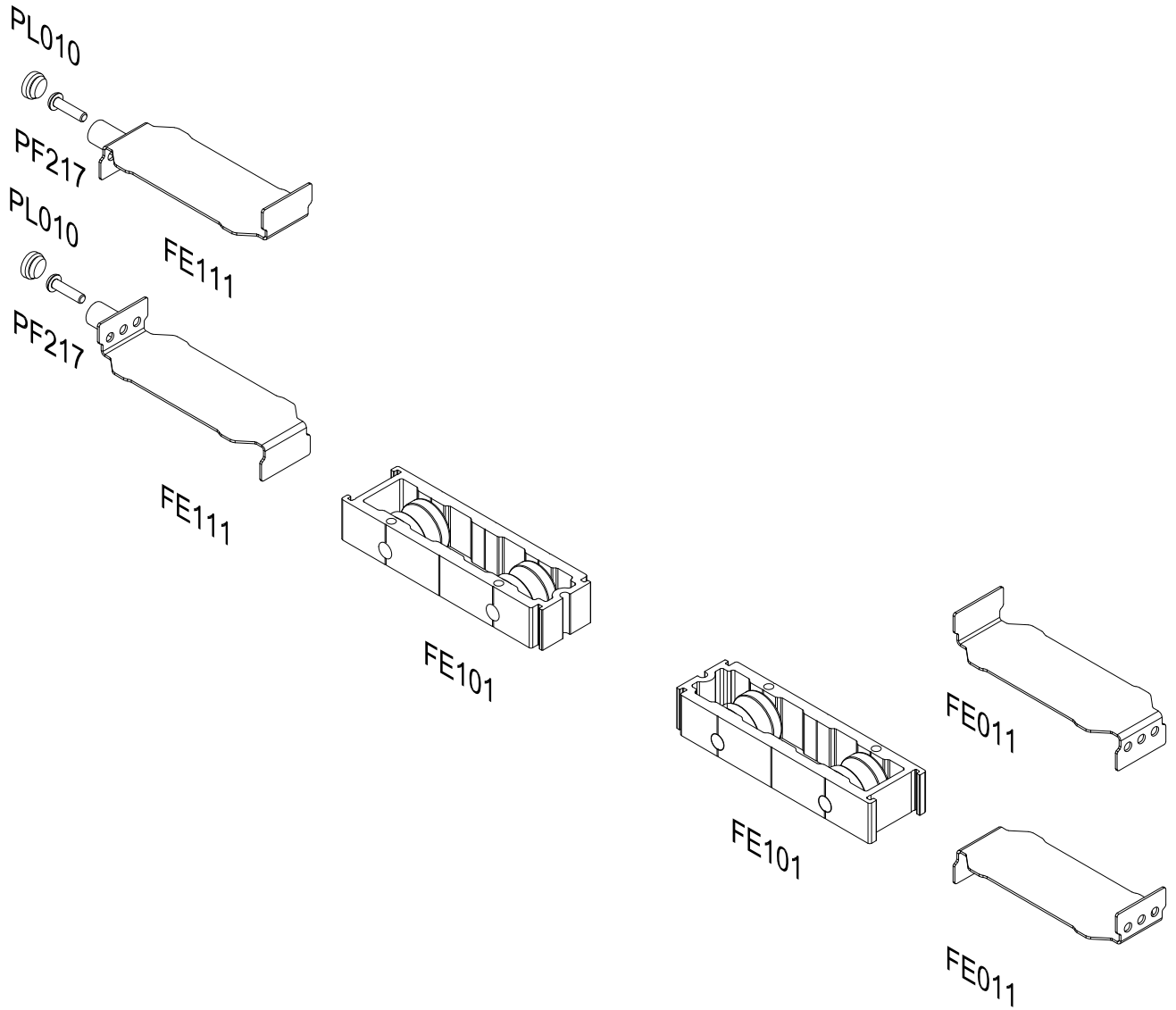

FE 1224 - KIT carro 1 hoja lateral

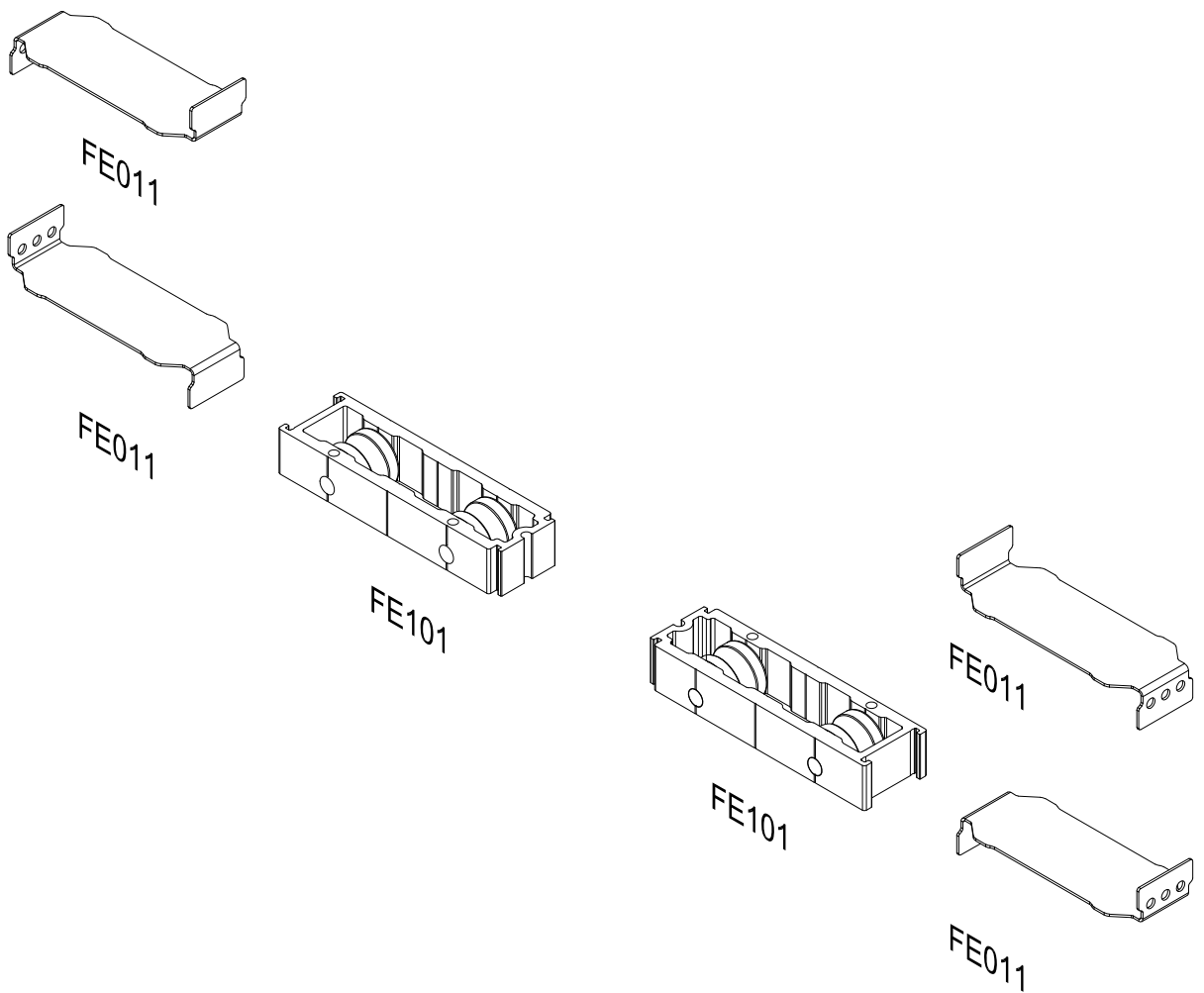

FE 1225 - KIT carro 1 hoja central

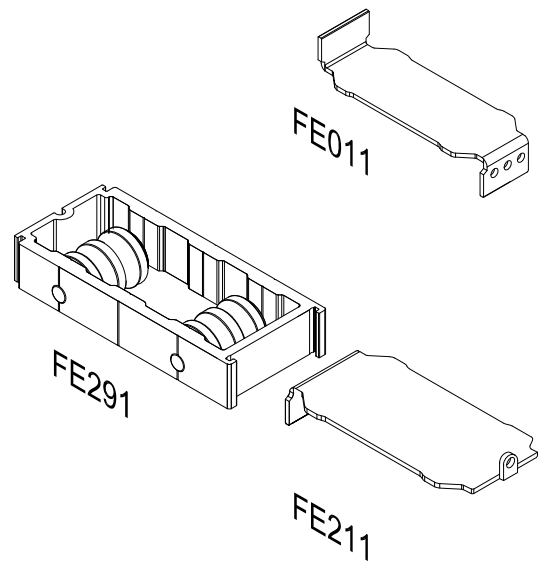
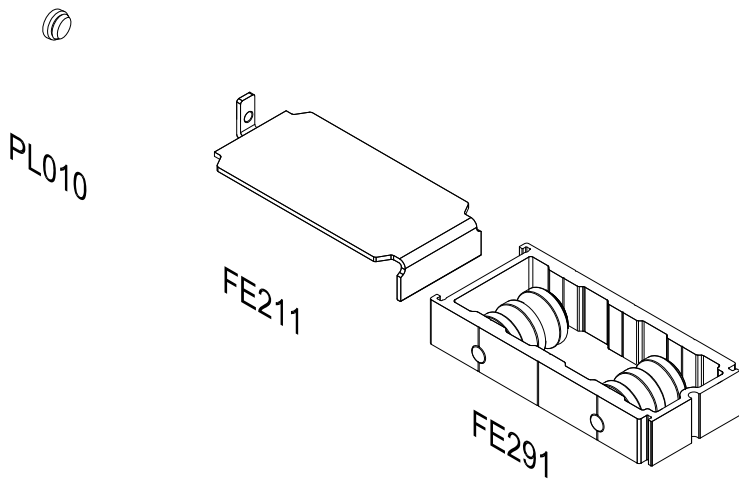
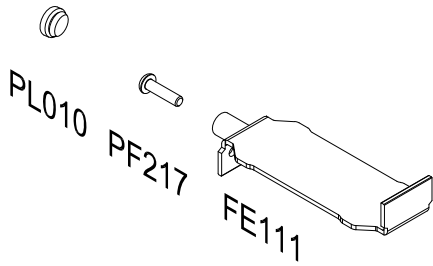

FE 1226 - KIT carro 1 hoja lateral (HR)

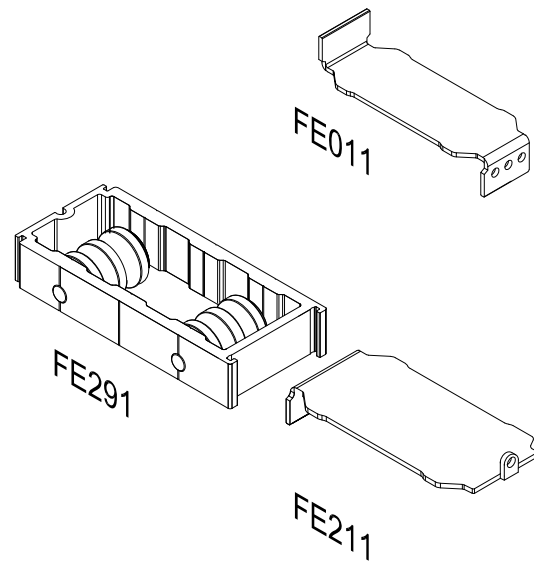
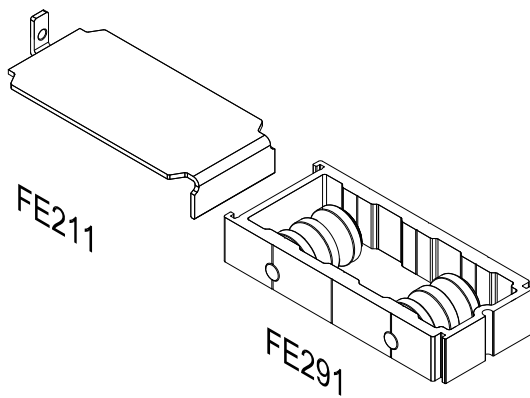
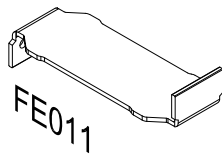

FE 1227 - KIT carro 1 hoja central (HR)

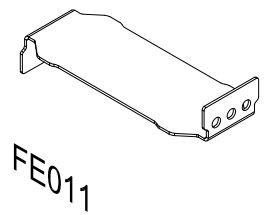
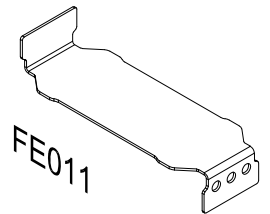
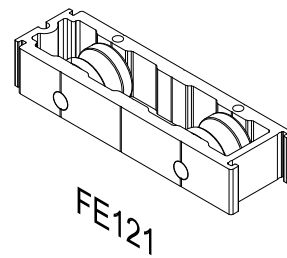
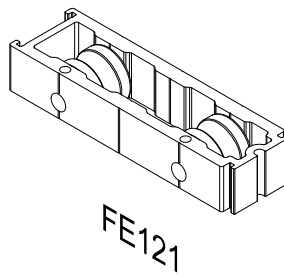
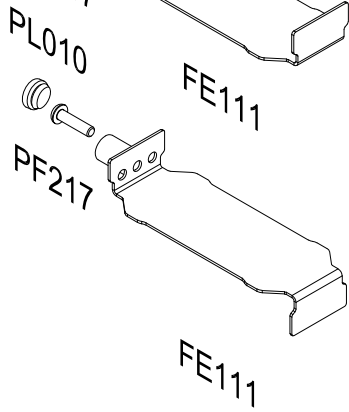
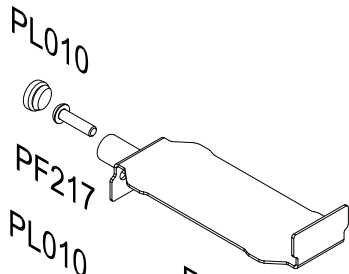

FE 1228 - KIT carro especial 1 hoja lateral

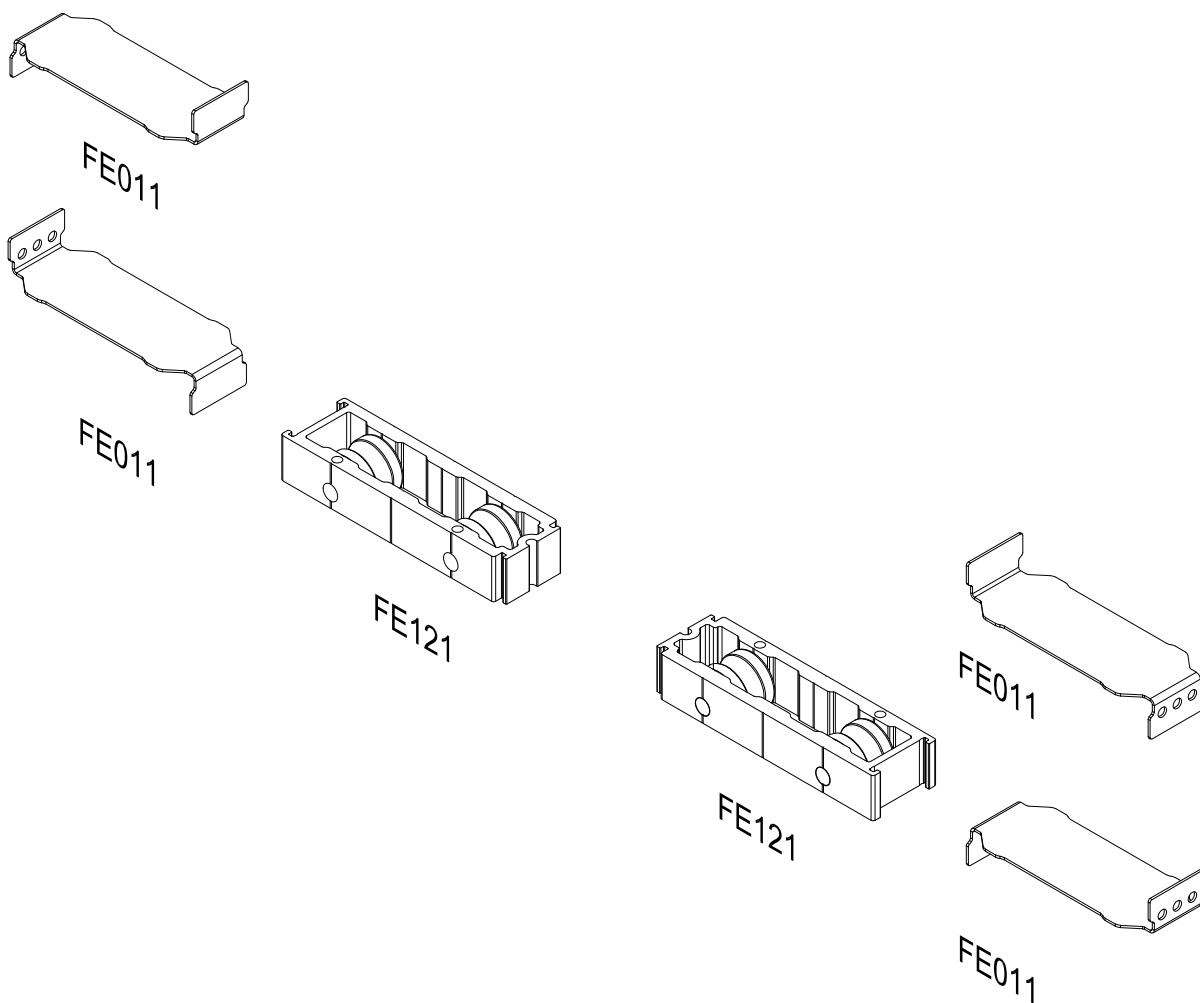



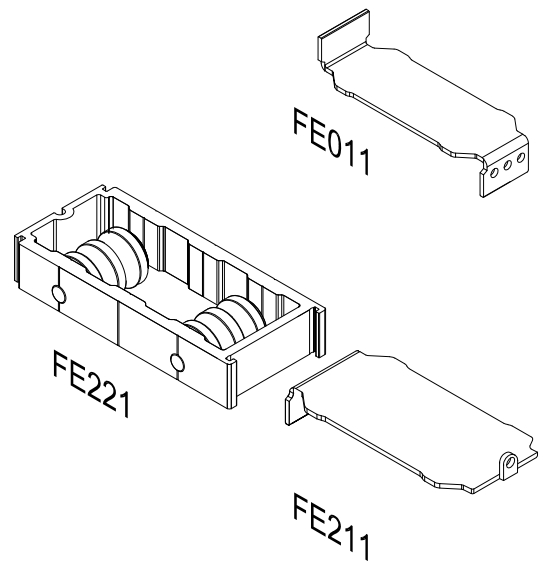
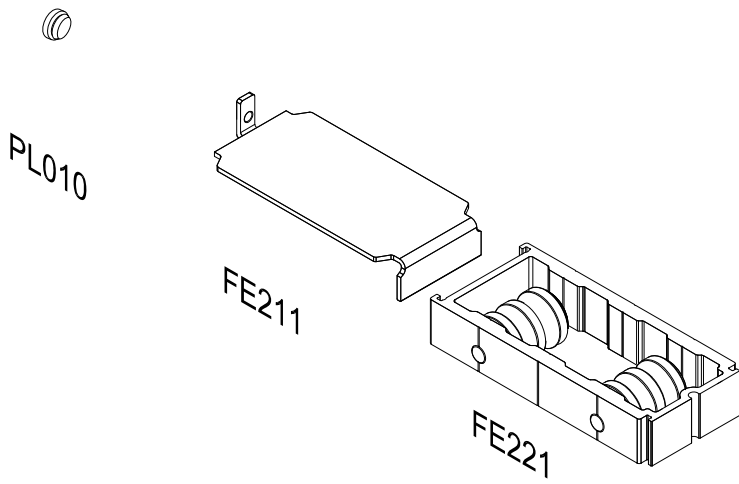
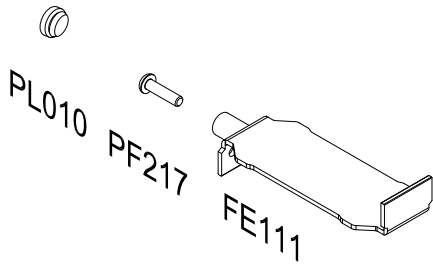

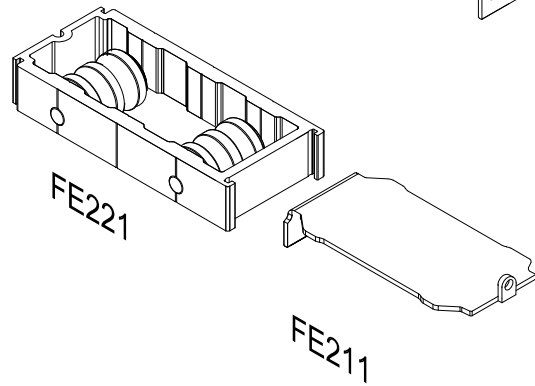
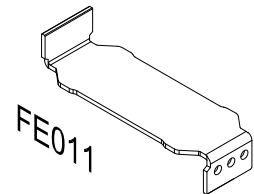
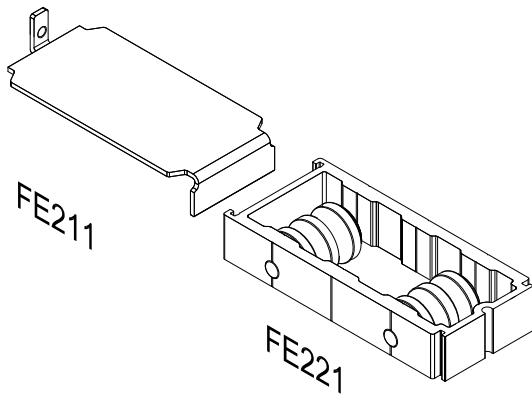
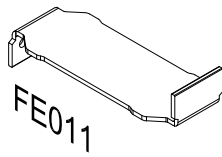

FE 1229 - KIT carro especial 1 hoja central



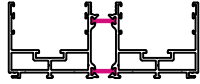
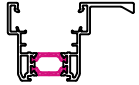

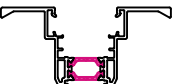
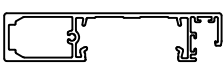

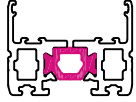

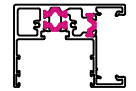



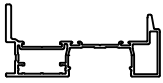

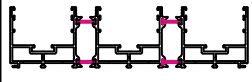
FE 1230 - KIT carro especial 1 hoja lateral (HR)

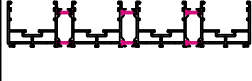
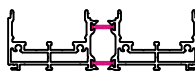
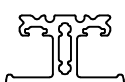

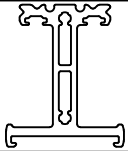

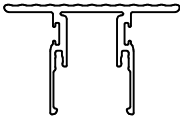

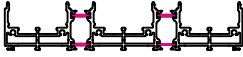
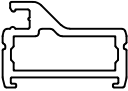
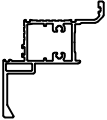
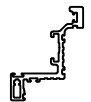

FE 1231 - KIT carro especial 1 hoja central (HR)

Referencia	Diseño	Descripción	Momentos de Inercia	
			Ix (cm ⁴)	Iy (cm ⁴)
EXP 001		marco dos carriles	19,79	144,50
EXP 002		hoja lateral con ala interior	19,18	32,87
EXP 003		hoja central sin refuerzo	1,29	13,52
EXP 004		hoja central sin refuerzo invertida	1,29	13,52
EXP 022		hoja lateral con alas	24,39	54,53
EXP 023		hoja central reforzada	2,60	43,24
EXP 024		hoja central reforzada invertida	2,77	43,25
EXP 025		hoja lateral oculta	2,14	8,00
EXP 025.1		suplemento hoja lateral oculta	0,67	3,71
EXP 030		hoja esquina	21,02	38,87

Referencia	Diseño	Descripción	Momentos de Inercia	
			Ix (cm ⁴)	Iy (cm ⁴)
EXP 031		marco monocarril	8,92	18,27
EXP 032		hoja lateral	11,90	16,48
EXP 033		hoja central reforzada	4,40	128,46
EXP 035		unión 4 hojas	9,24	82,79
EXP 040		marco inferior pivotante	1,39	11,50
EXP 041		marco tres carriles	32,02	525,70
EXP 042		marco fijo pivotante	14,65	5,59
EXP 044		marco cuatro carriles	44,11	1306,36
EXP 051		marco solera oculta	10,53	147,21
EXP 052		suplemento 27 mm	-	-

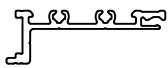
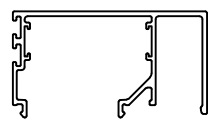
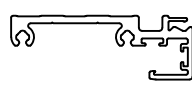
Referencia	Diseño	Descripción	Momentos de Inercia	
			Ix (cm ⁴)	Iy (cm ⁴)
EXP 053		suplemento 47 mm	-	-
EXP 056		remate lateral solera oculta	-	-
EXP 057		remate central solera oculta	-	-
EXP 058		tapa 24 mm	-	-
EXP 059		remate lateral solera oculta	-	-
EXP 060		tapa de remate	-	-
EXP 061		marco solera oculta tres carriles	16,73	535,64
EXP 065		hoja mosquitera	-	-
EXP 070		hoja esquina oculta	19,62	21,30
EXP 071		hoja esquina oculta	13,30	8,55

Referencia	Diseño	Descripción	Momentos de Inercia	
			Ix (cm ⁴)	Iy (cm ⁴)
EXP 074		marco solera oculta cuatro carriles	23,01	1329,73
EXP 085		envolvente de vidrio	-	-
EXP 086		envolvente de vidrio (poliamida)	-	-
EXP 100		guía acero inox 8 mm	-	-
EXP 105		remate interior	-	-
EXP 106		clip galandage interior	-	-
EXP 107		tapa galandage interior	-	-
EXP 108		cruce galandage interior	-	-
EXP 155		envolvente de vidrio solera oculta (poliamida)	-	-

EXP031

EXP100

EXP060

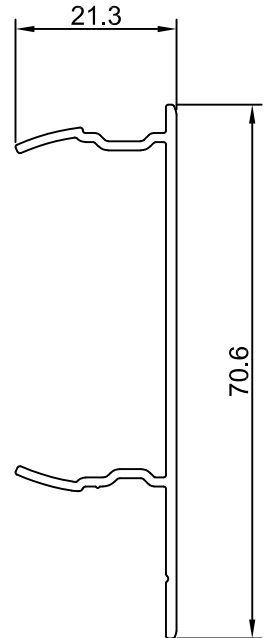
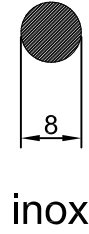
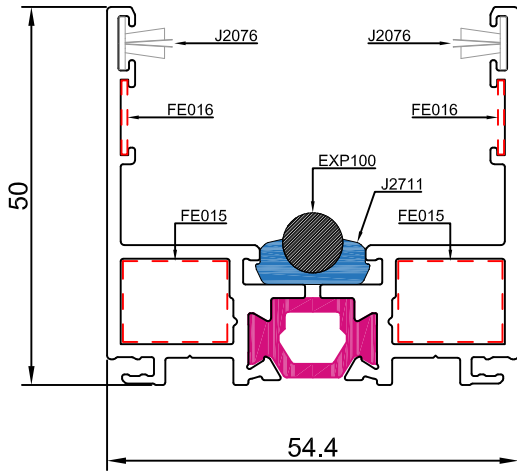

EXP001

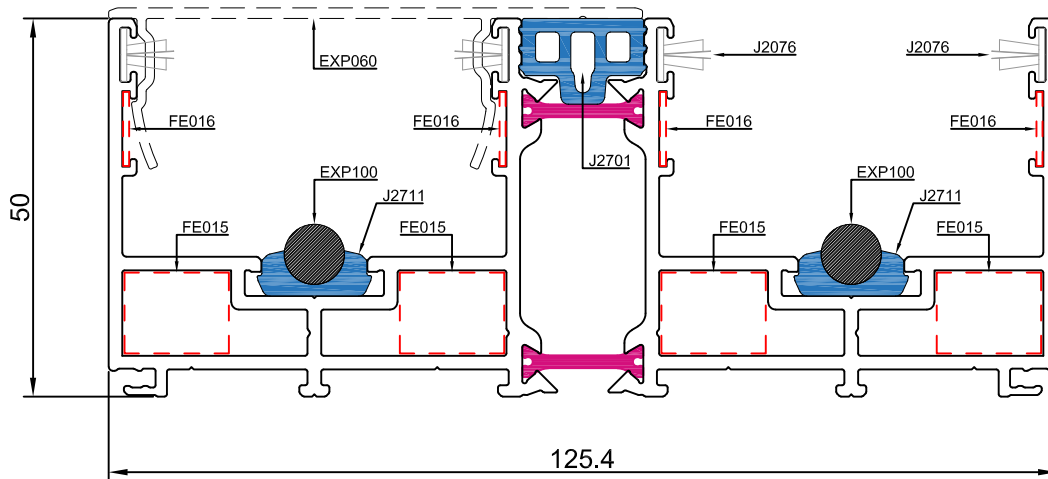

EXP041

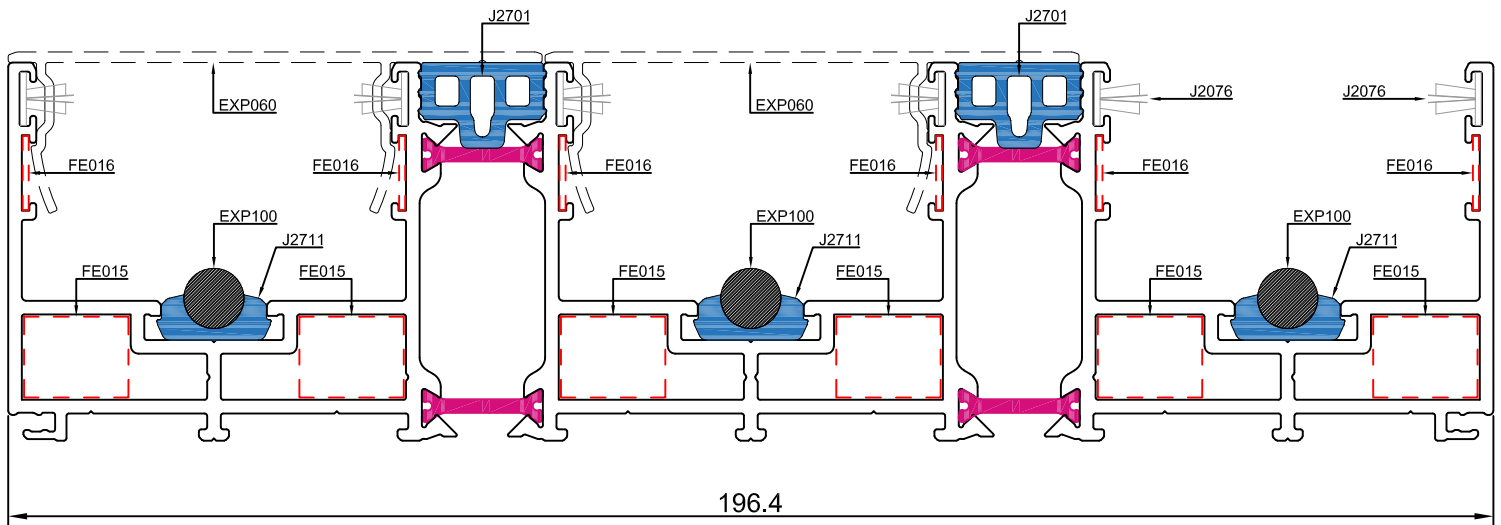

EXP044

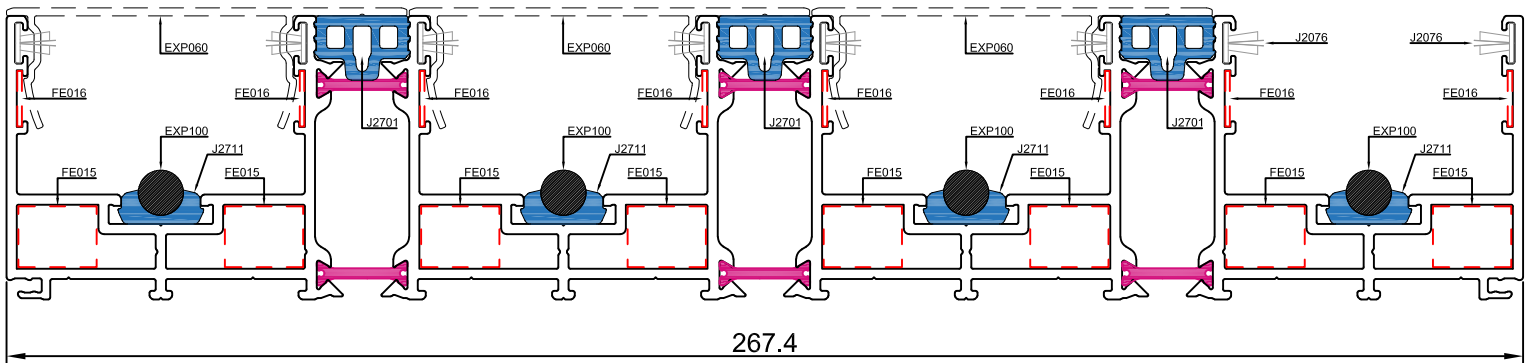

EXP032

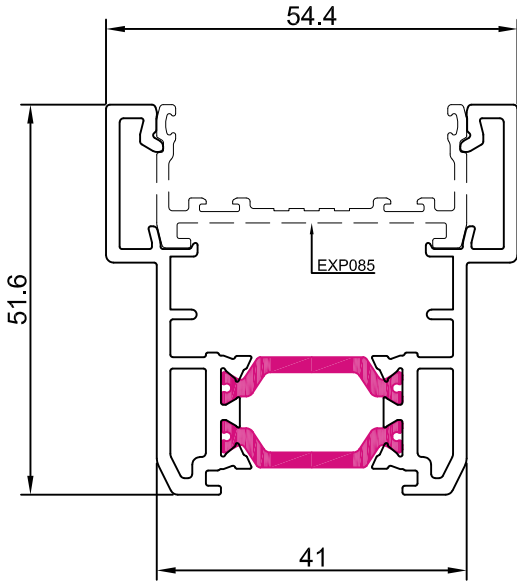

EXP002

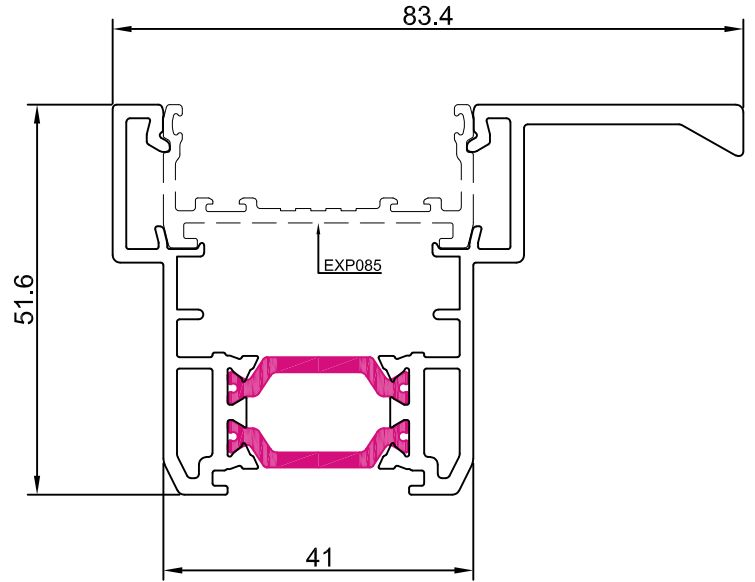

EXP022

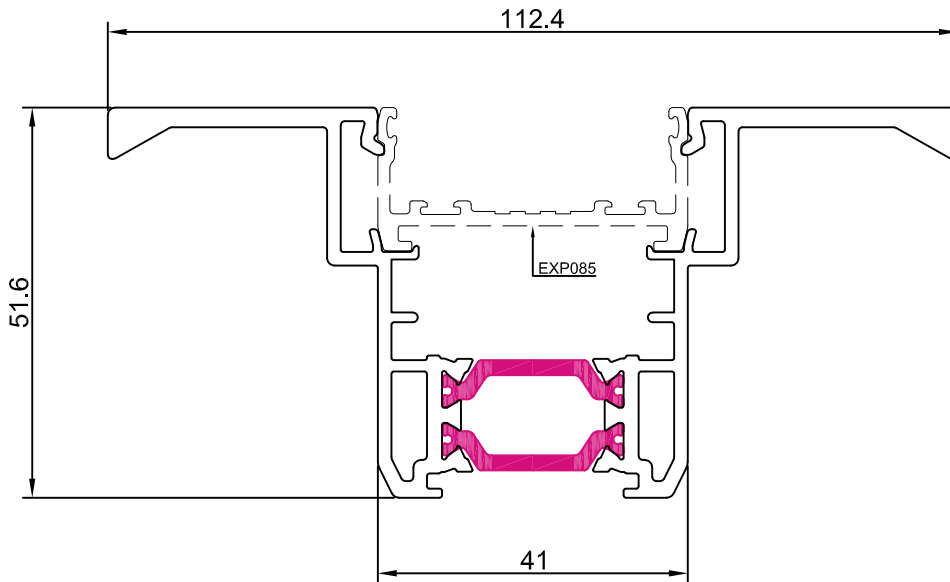

EXP003

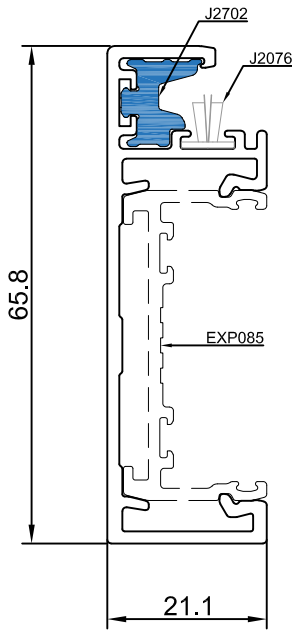

EXP023

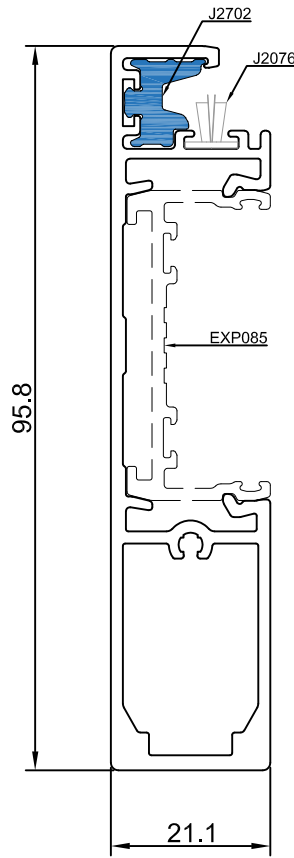

EXP033

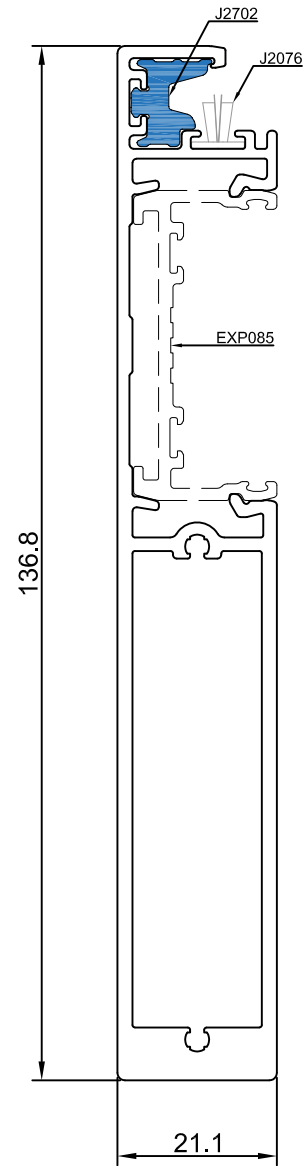

EXP004

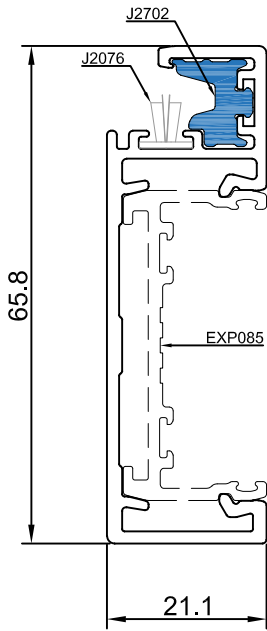

EXP024

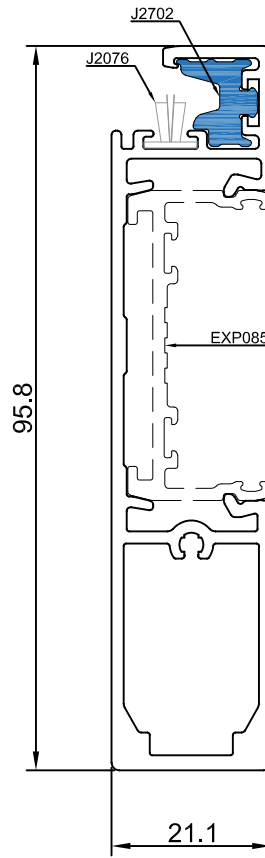

EXP035

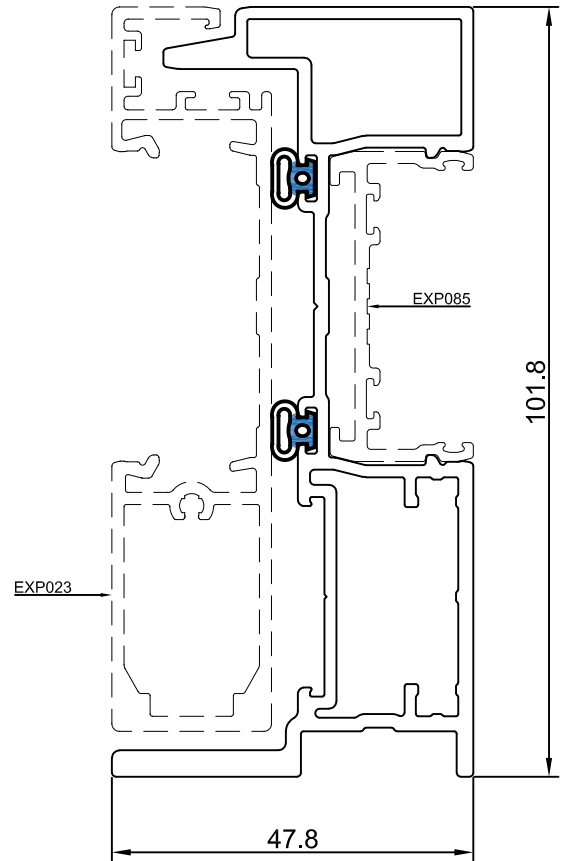

aluminio

EXP085

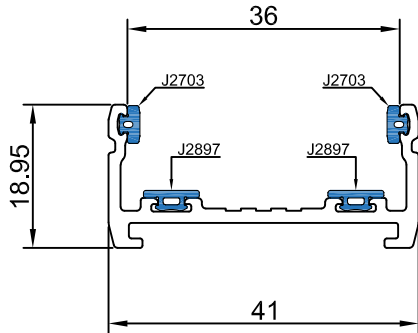

EXP086

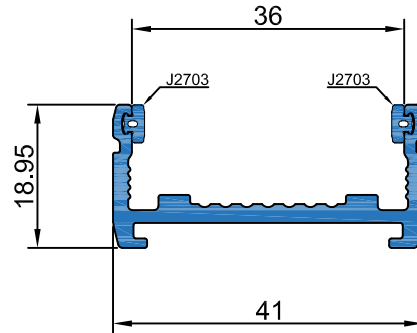

poliamida

(se debe utilizar siempre con vidrios no templados para evitar el riesgo de choque térmico)

EXP030

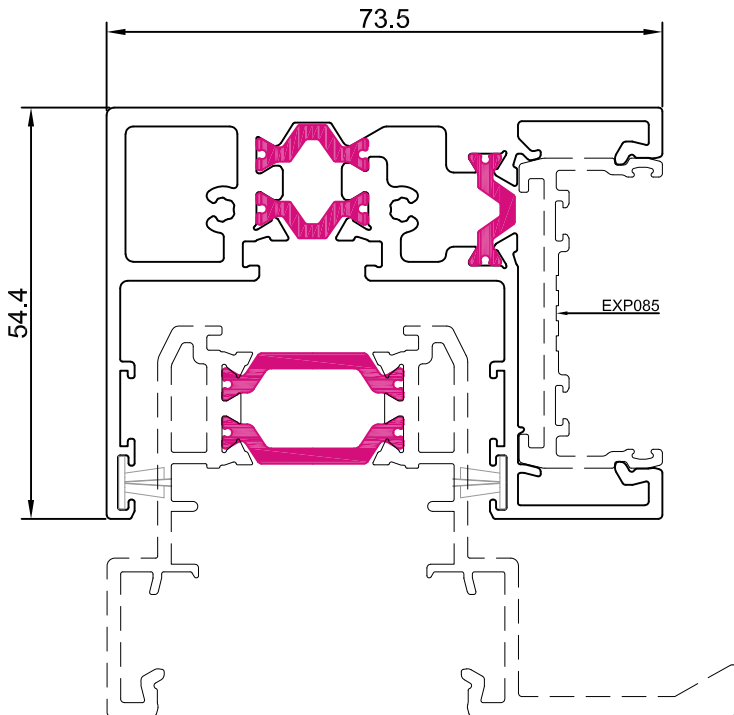

EXP065

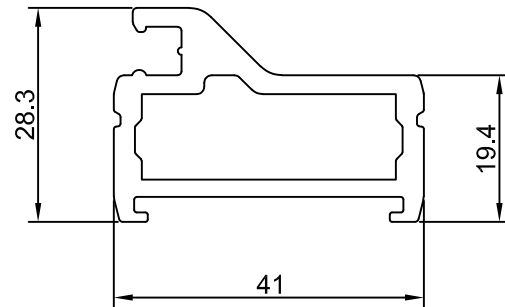

EXP070

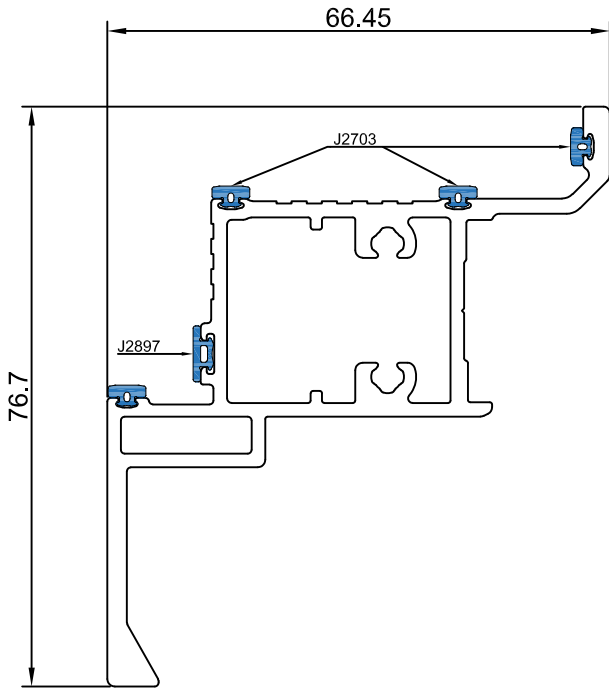

EXP071

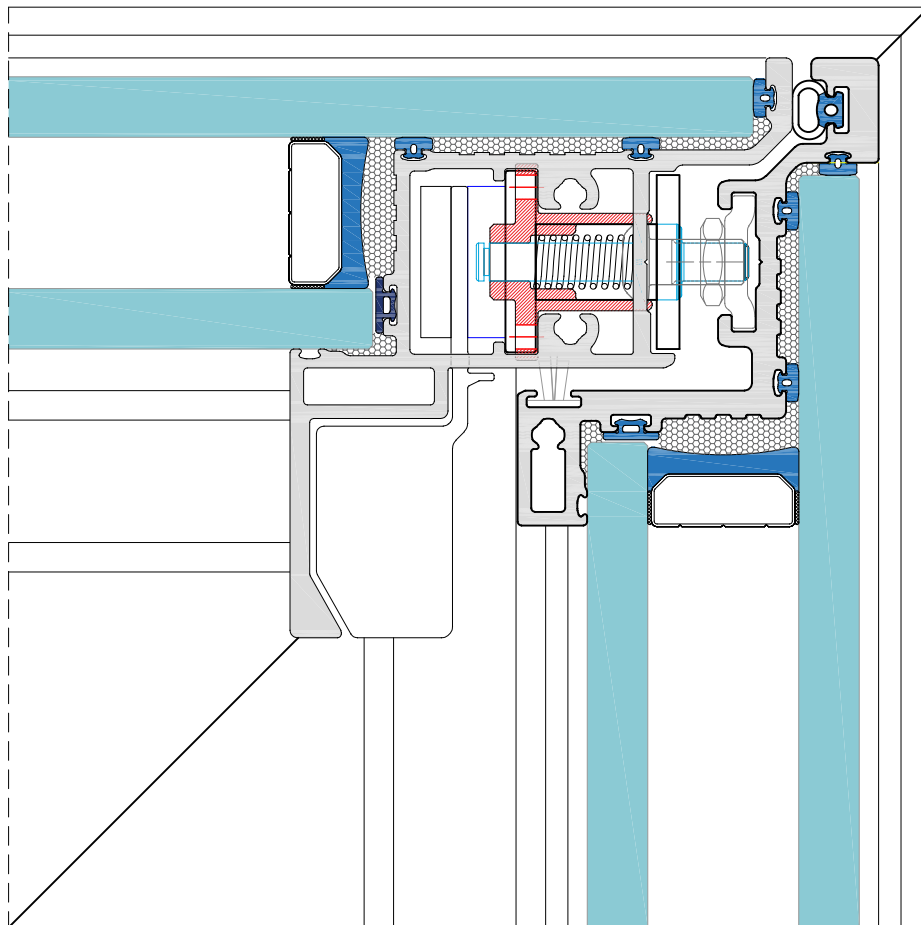
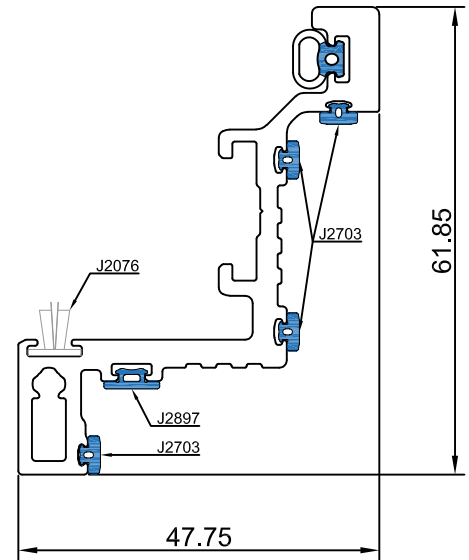

EXP051

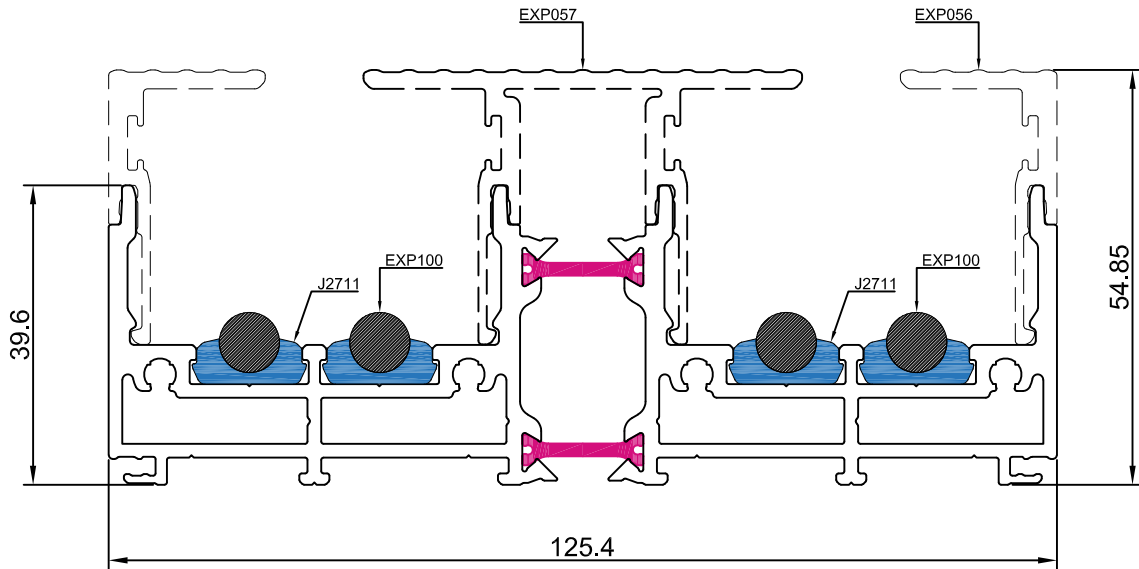

EXP056

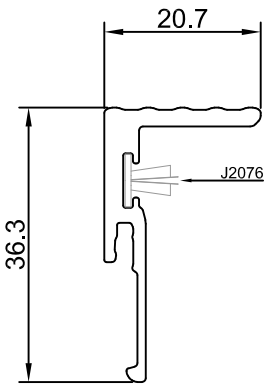

EXP059

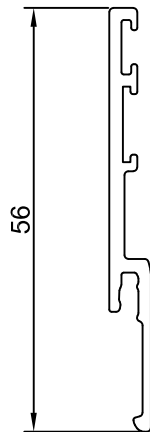

EXP057

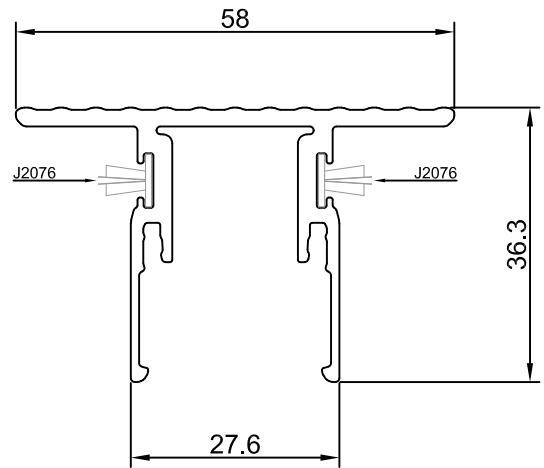

EXP061

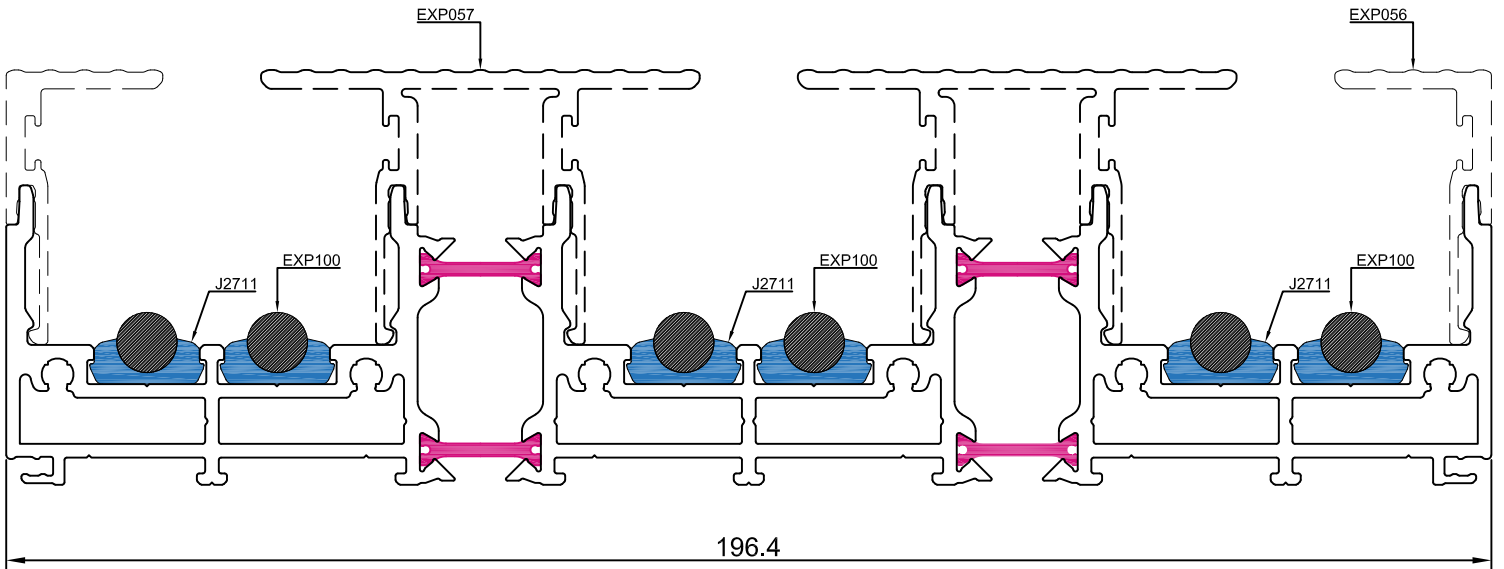

EXP074

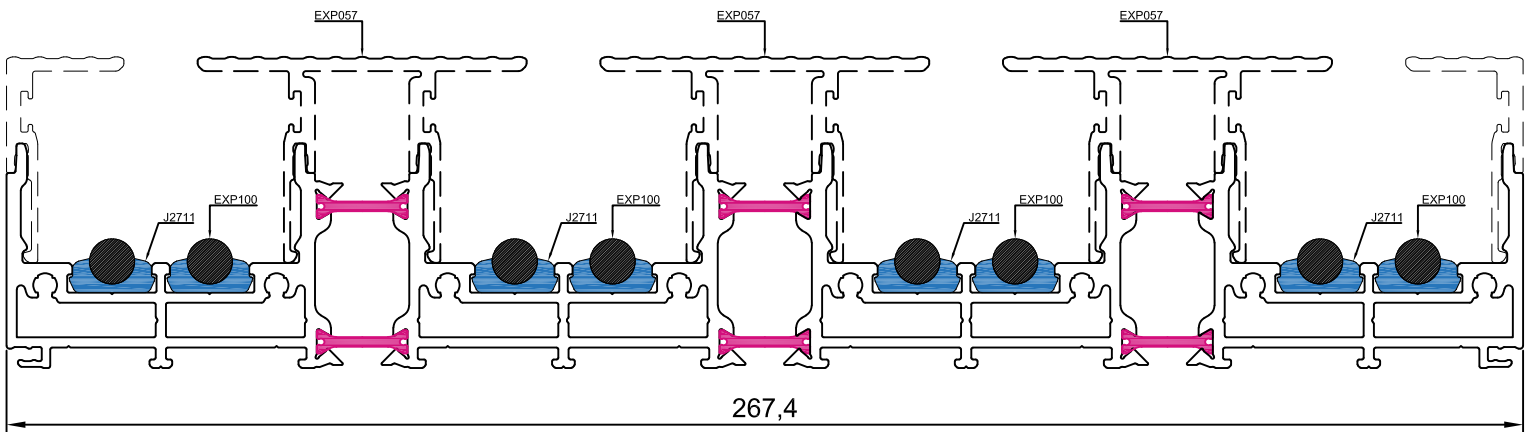

EXP155

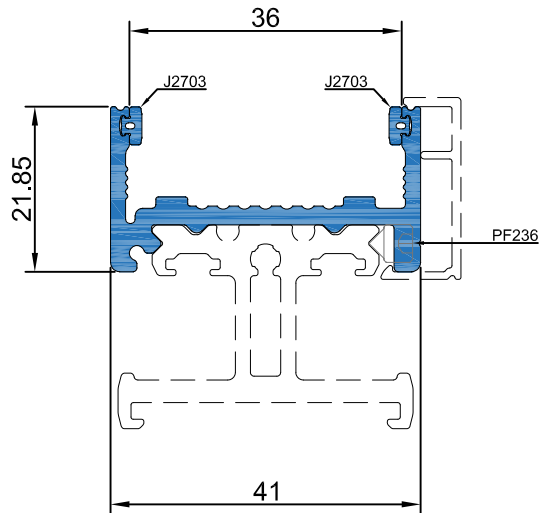

poliamida

EXP058

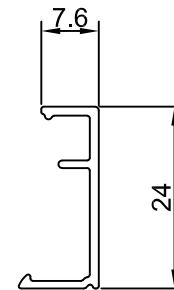

EXP052

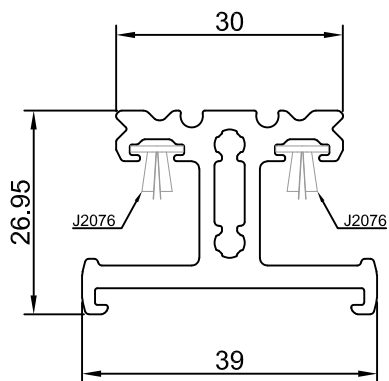

EXP053

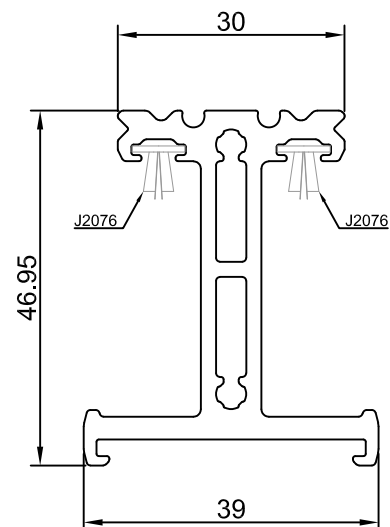

EXP040

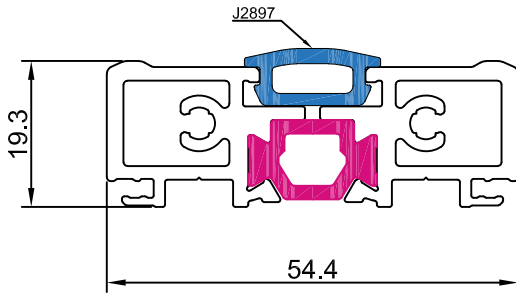

EXP042

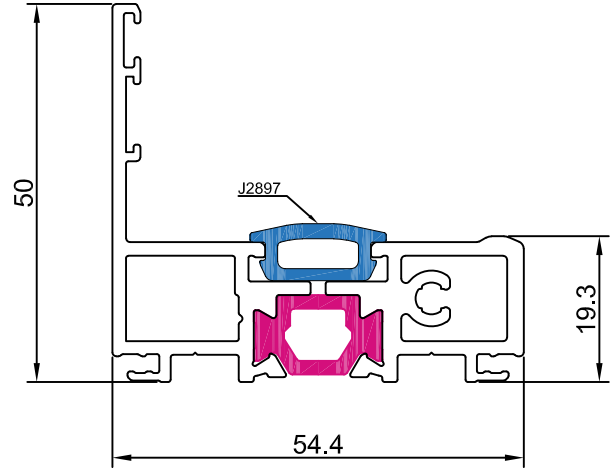

EXP025

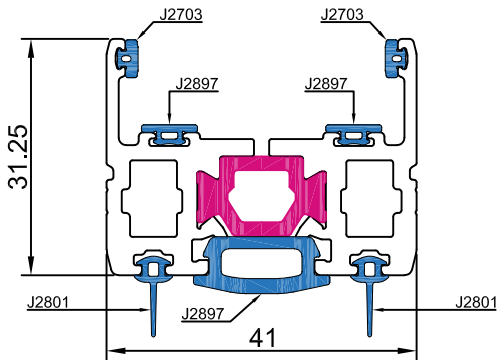

EXP025.1

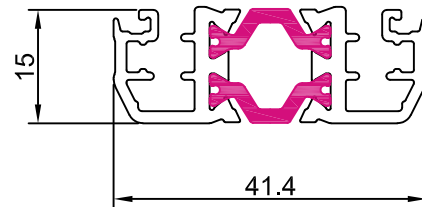

EXP105

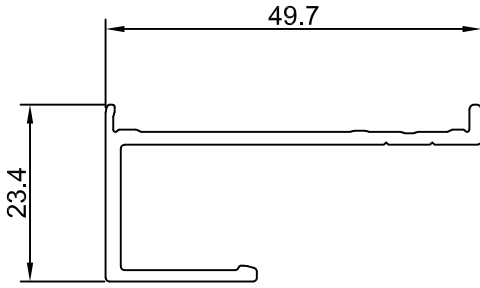

EXP107

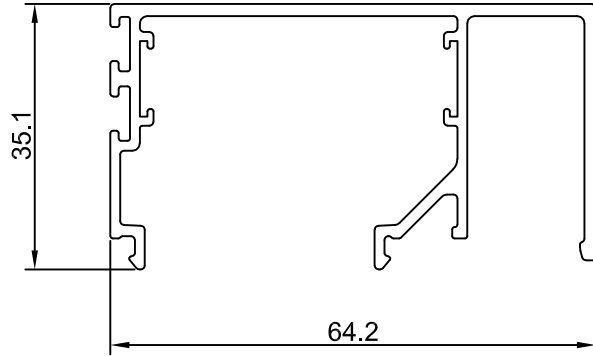

EXP108

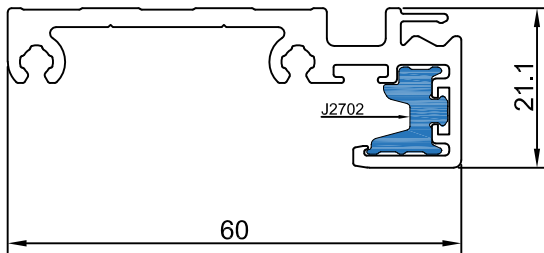

EXP106

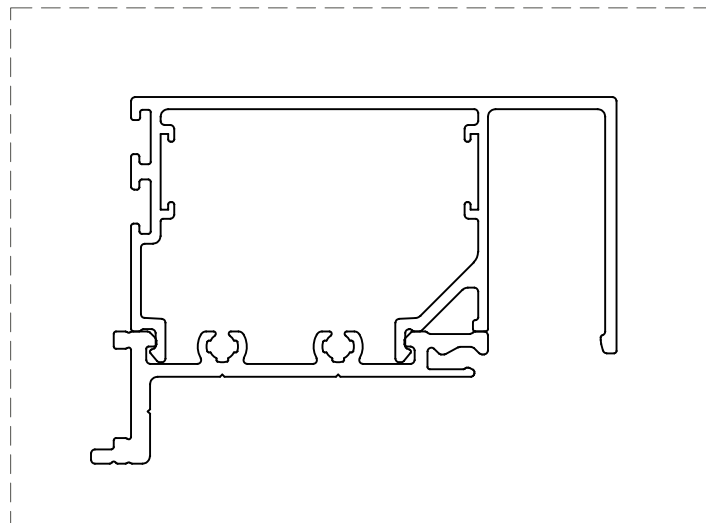
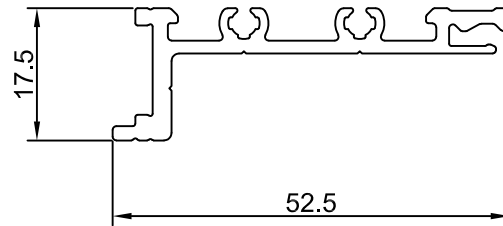

QEXP-C

ESTÁNDAR

"Nada es imposible ..."

La versatilidad de un sistema corredera, combinado con una opción multicarril y asociado a su elevada capacidad mecánica con la posibilidad de aperturas motorizadas secuenciales de varias hojas, permiten al sistema **QEXP-C ESTÁNDAR** cumplir con todas las exigencias técnicas y estéticas impuestas por los requisitos arquitectónicos.

aluminio

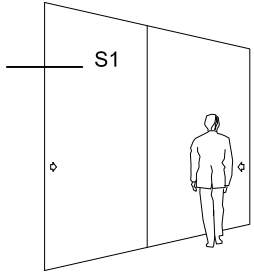

QEXP-C ESTÁNDAR

sección 1

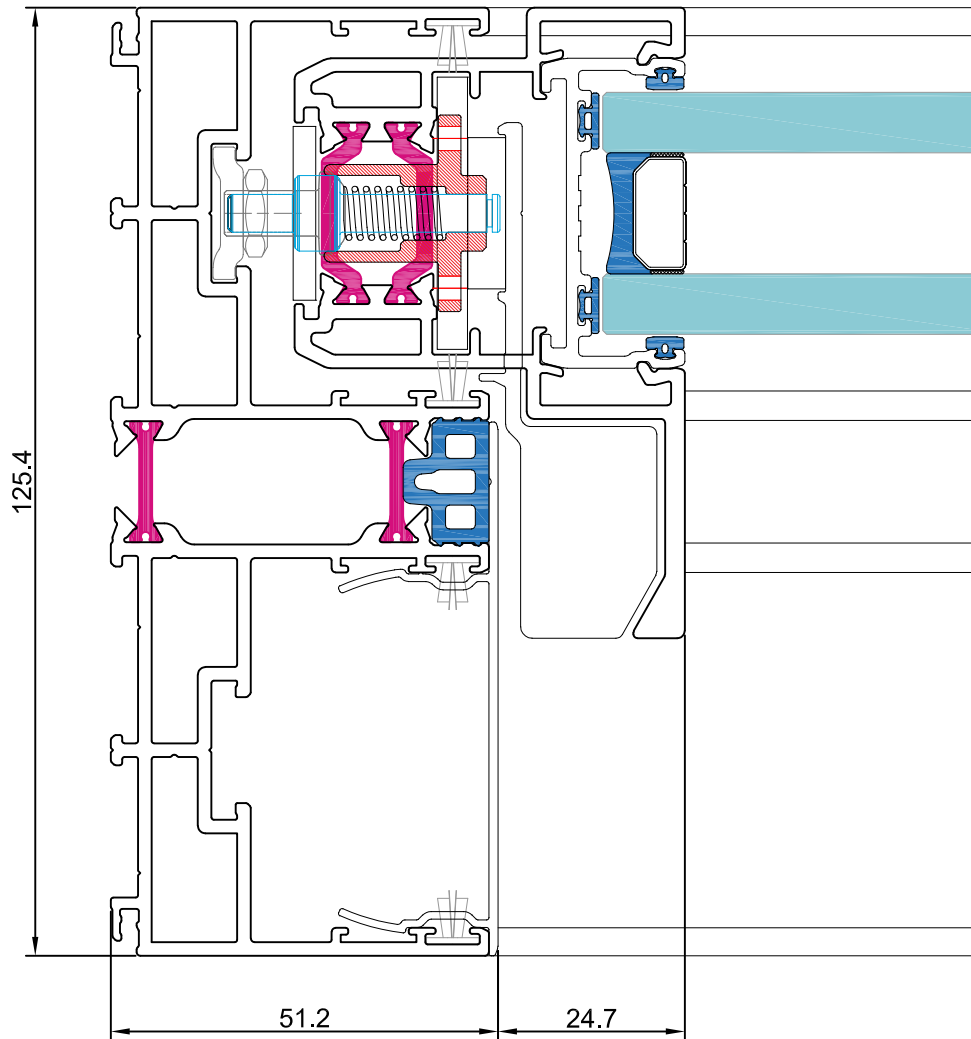

aluminio

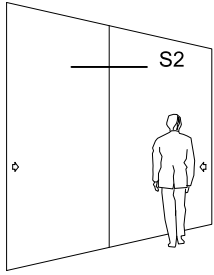

QEXP-C ESTÁNDAR

sección 2

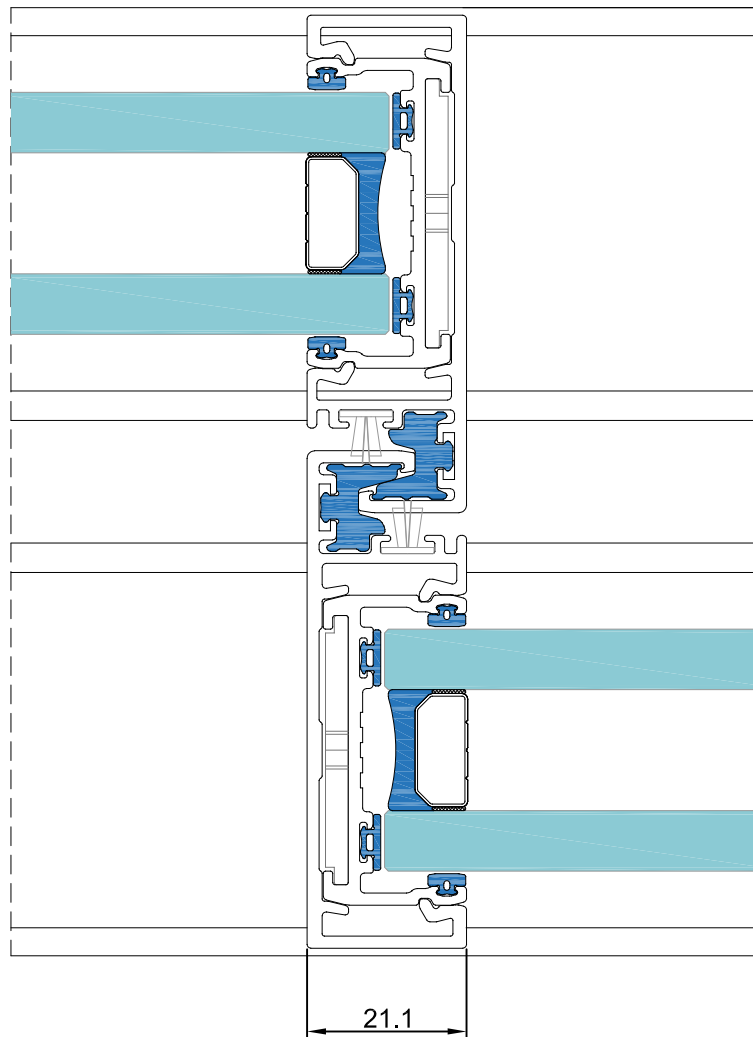

aluminio

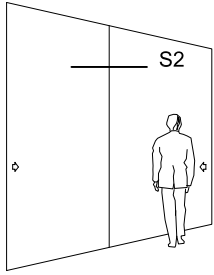

QEXP-C ESTÁNDAR

sección 2

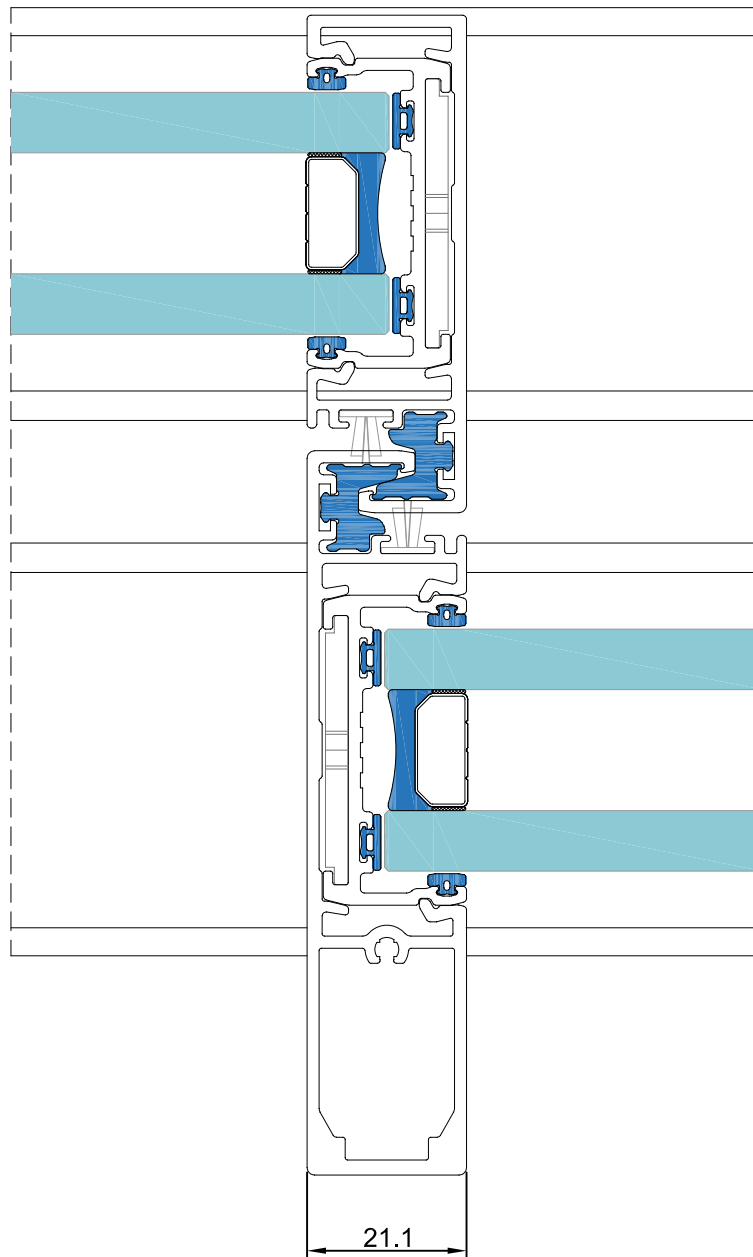

aluminio

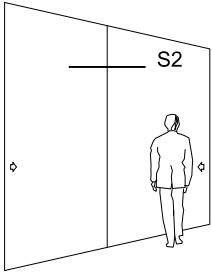

sección 2

QEXP-C ESTÁNDAR

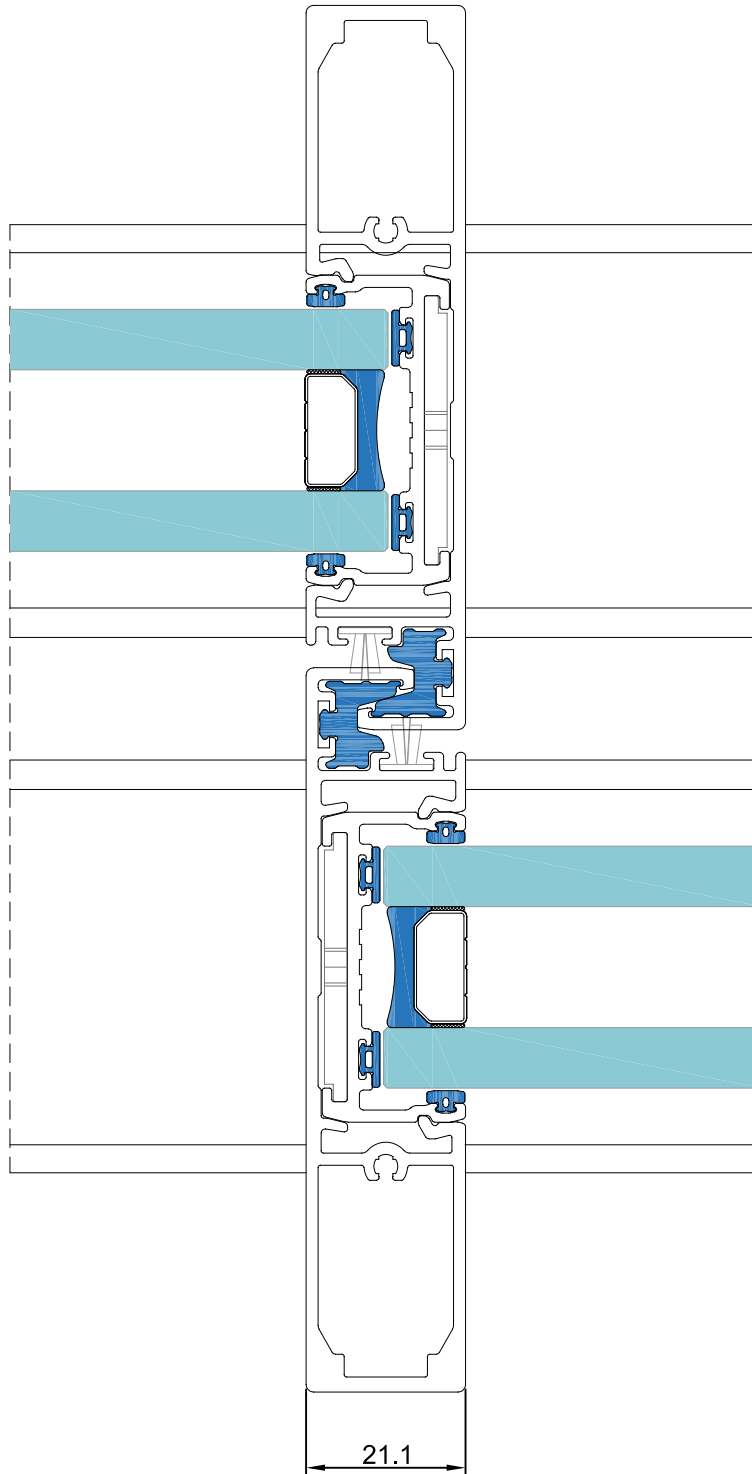

aluminio

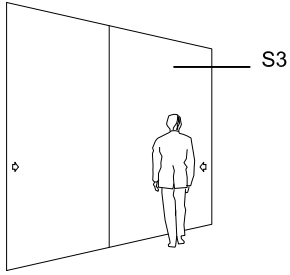

QEXP-C ESTÁNDAR

sección 3

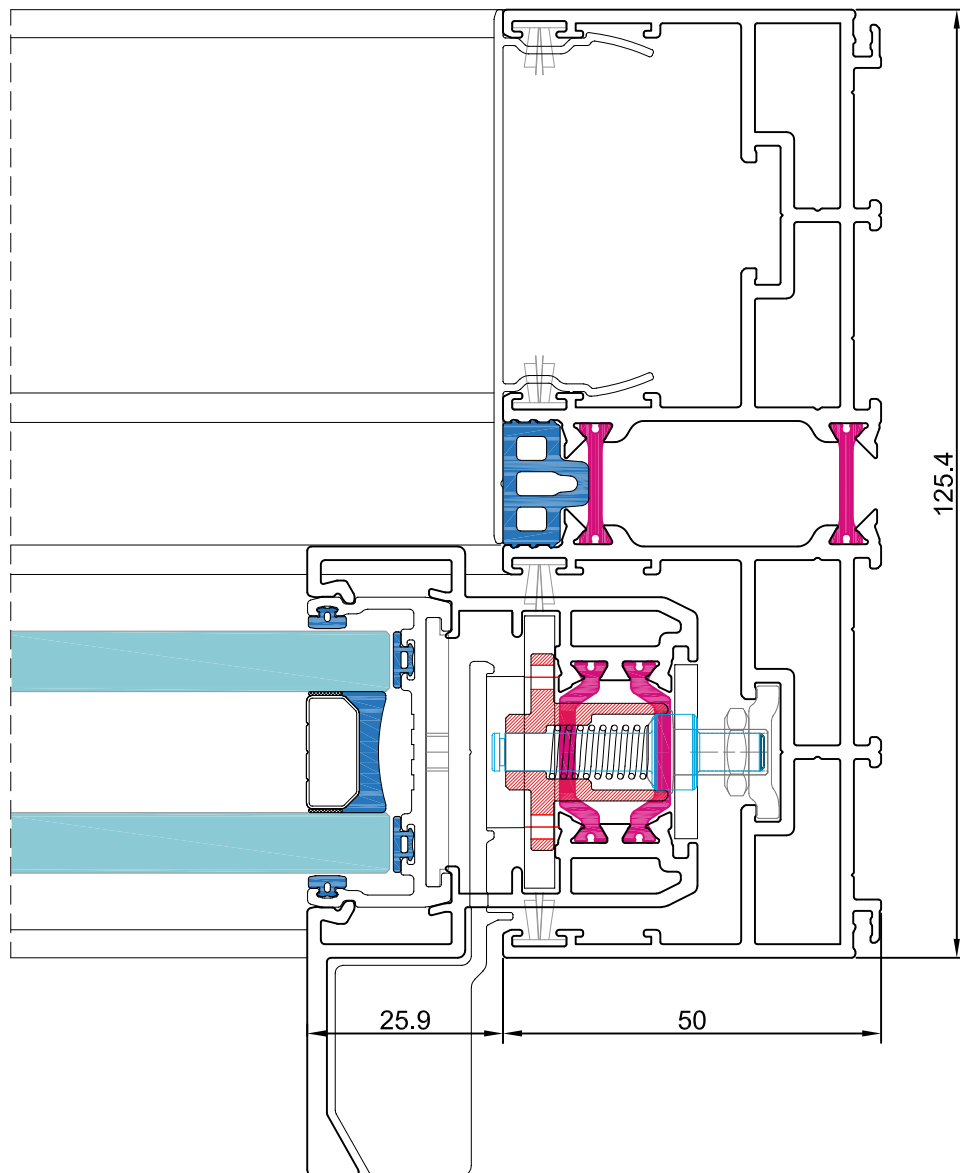

aluminio

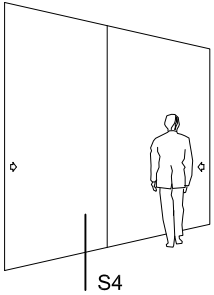

sección 4

QEXP-C ESTÁNDAR

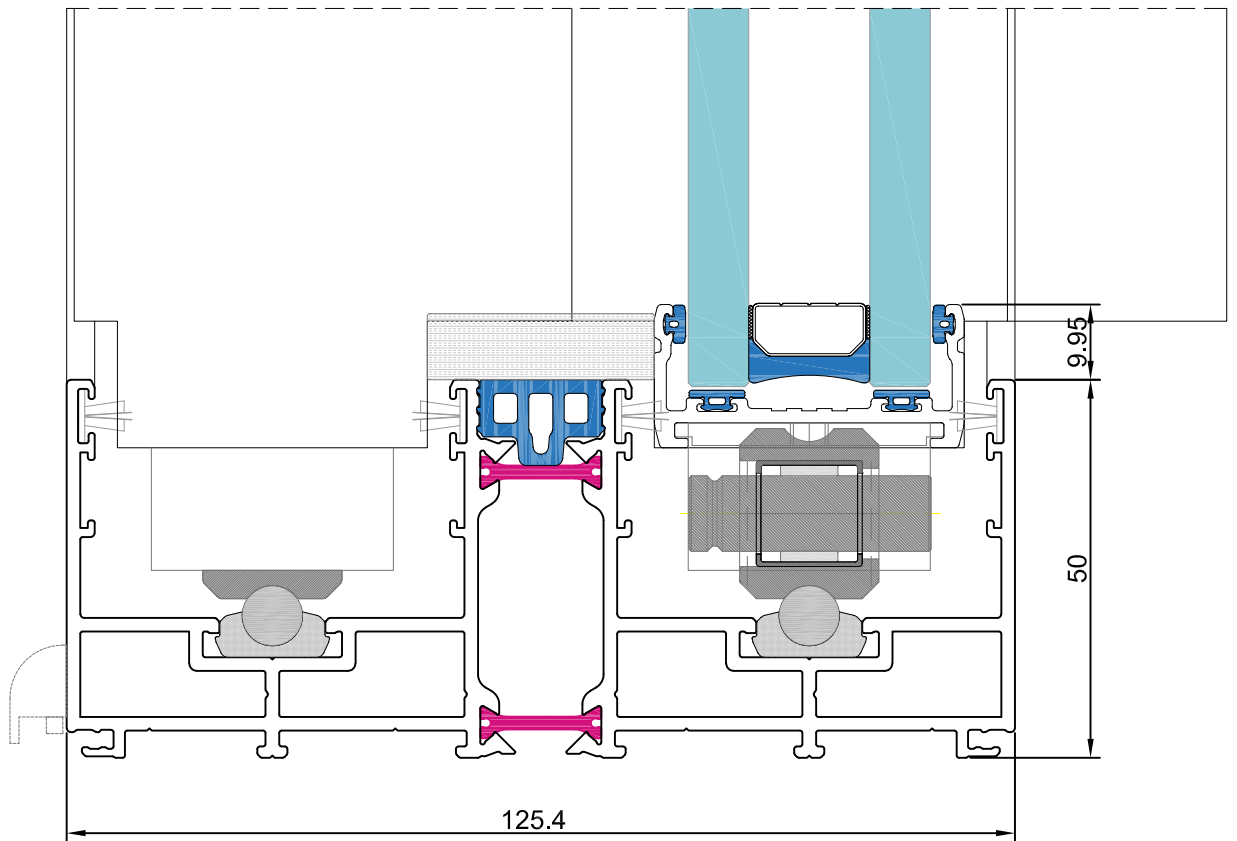

aluminio

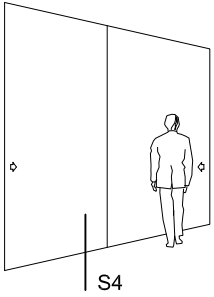

sección 4

QEXP-C ESTÁNDAR

opción SOLERA OCULTA

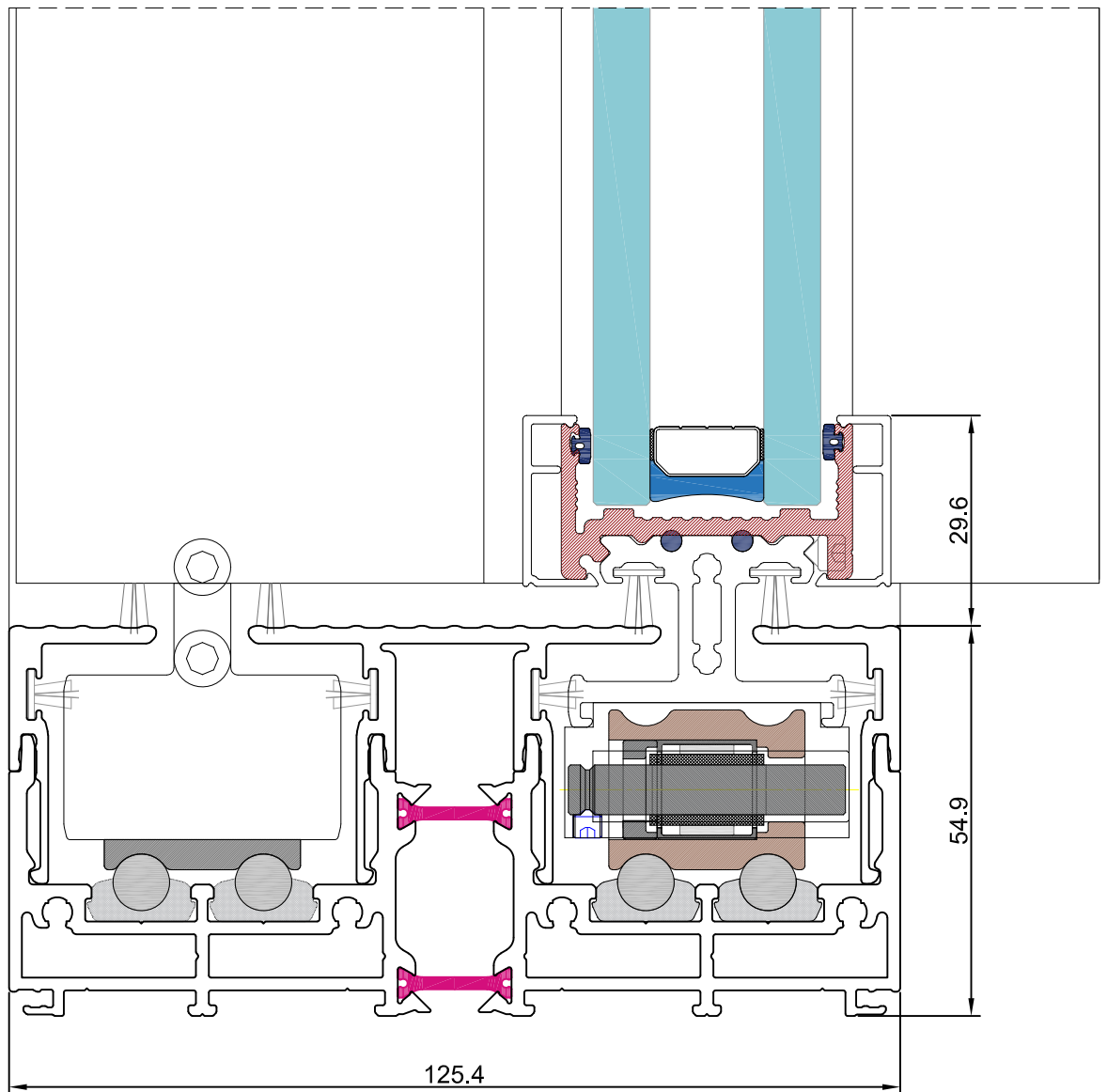

aluminio

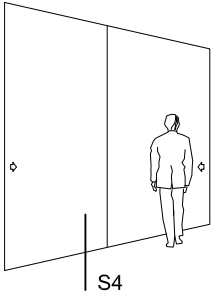

sección 4

QEXP-C ESTÁNDAR

opción SOLERA OCULTA

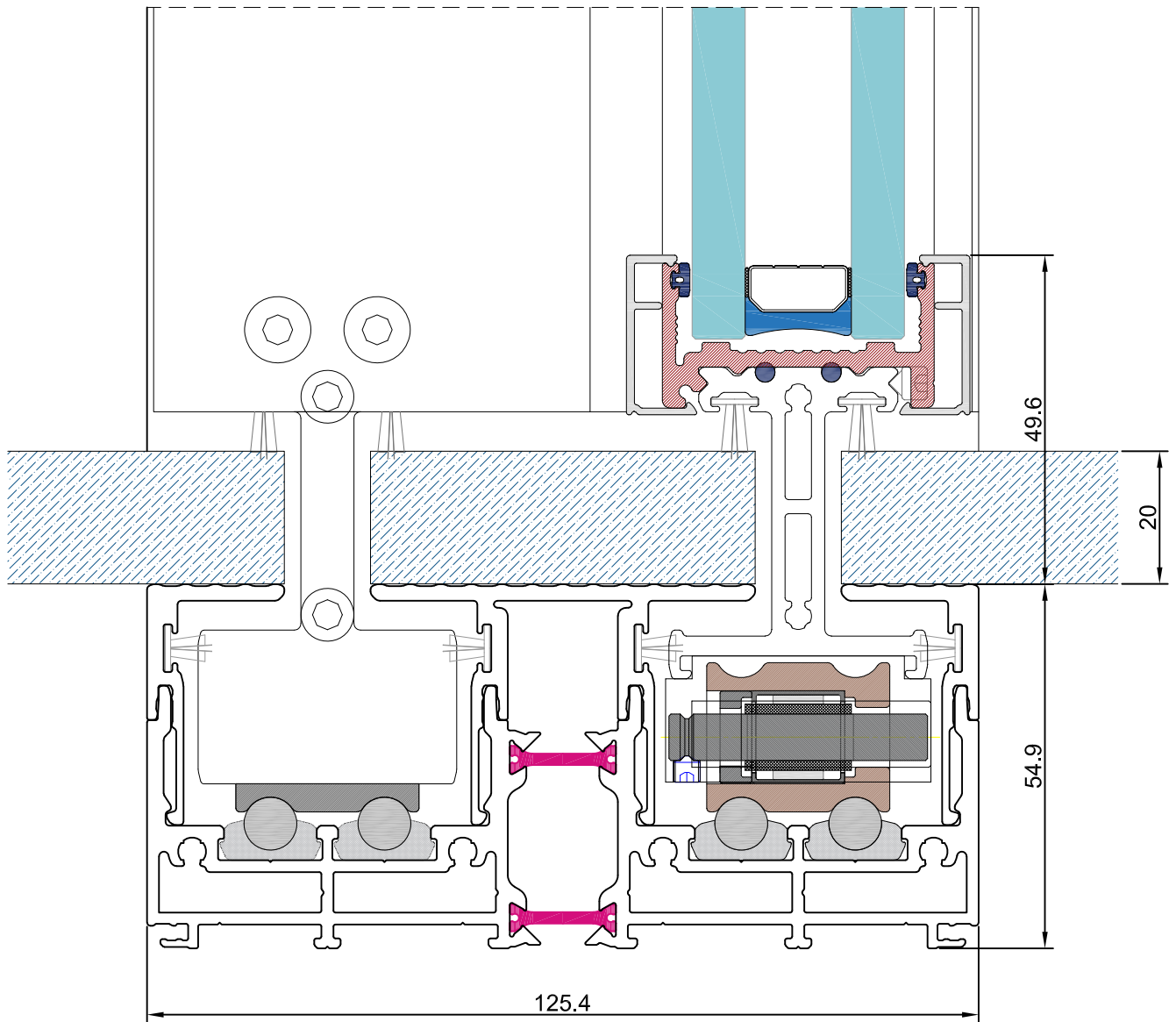

aluminio

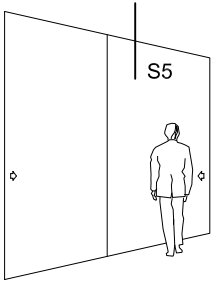

QEXP-C ESTÁNDAR

sección 5

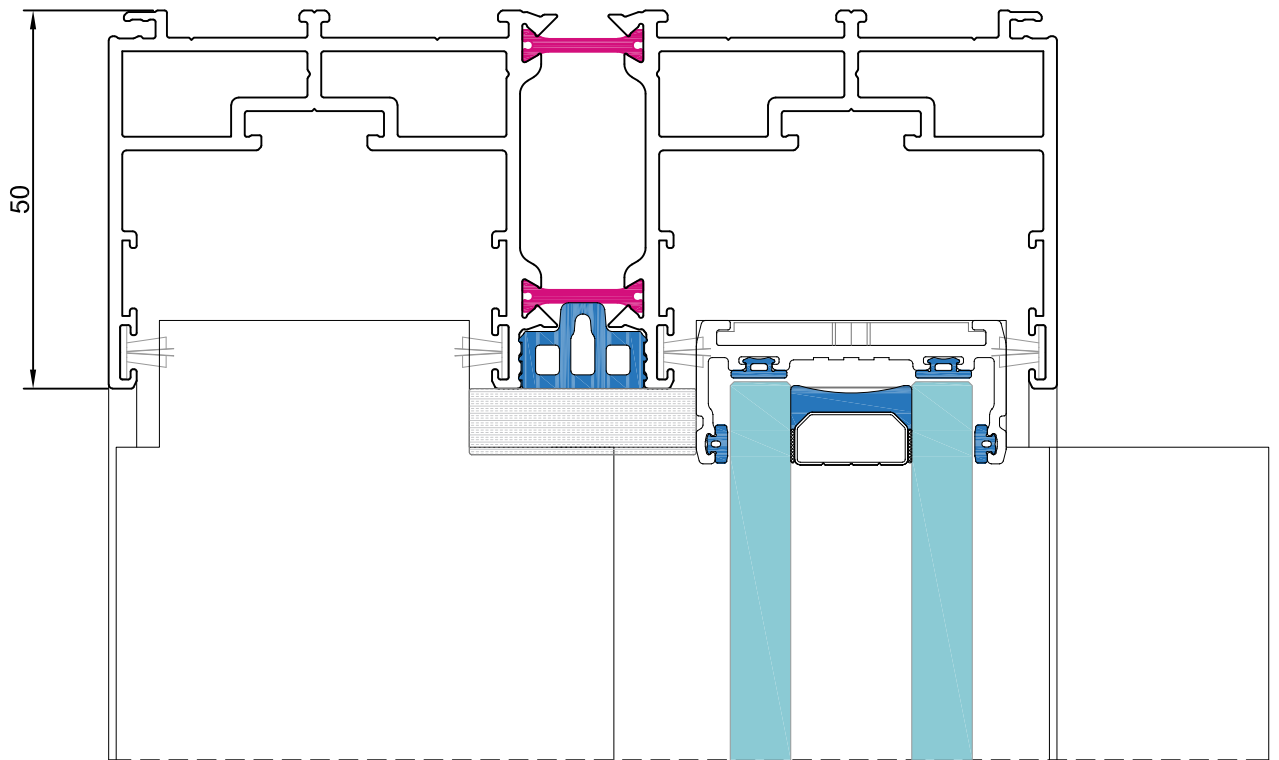

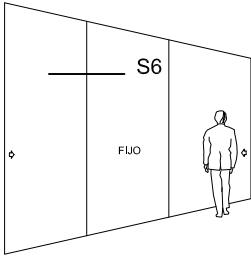

QEXP-C ESTÁNDAR

sección 6

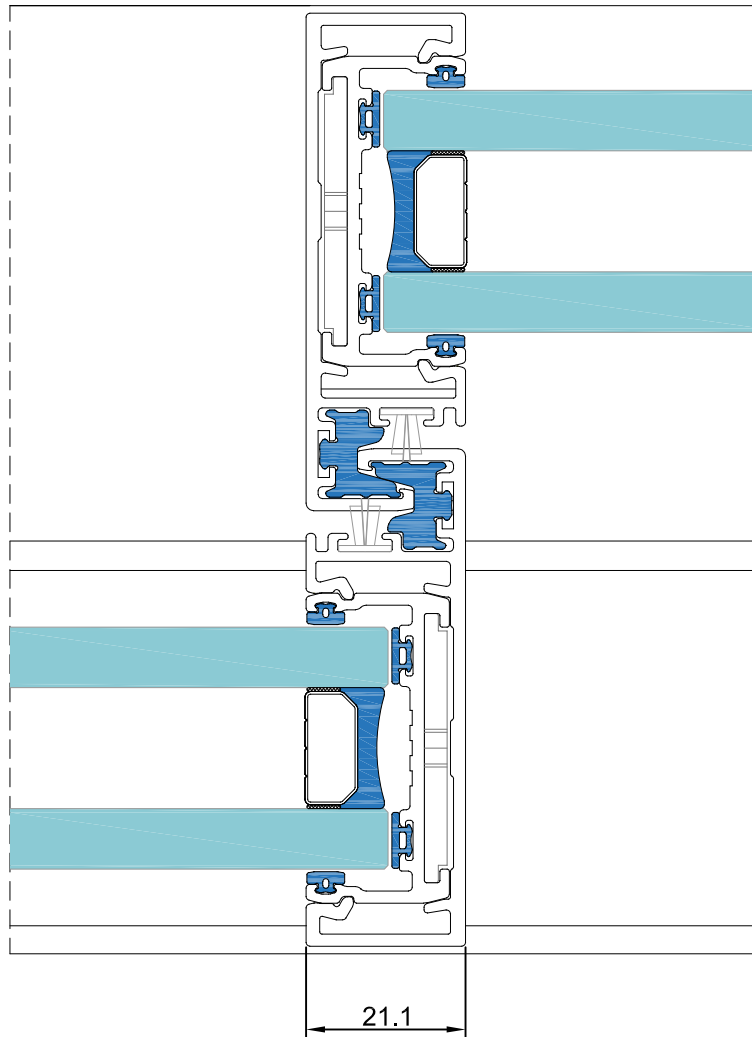

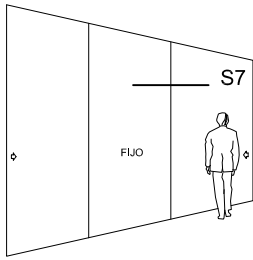

QEXP-C ESTÁNDAR

sección 7

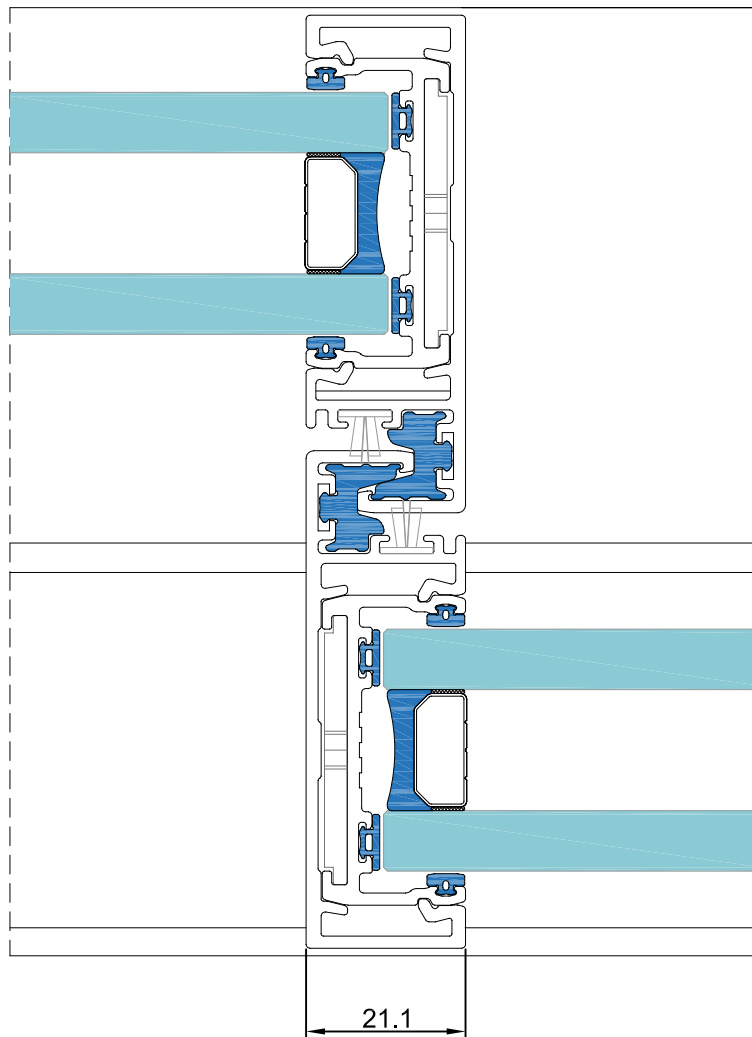

aluminio

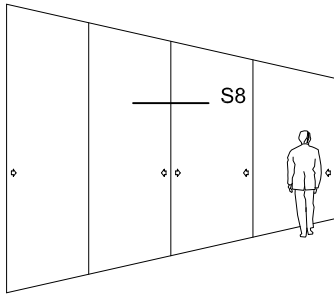

QEXP-C ESTÁNDAR

sección 8

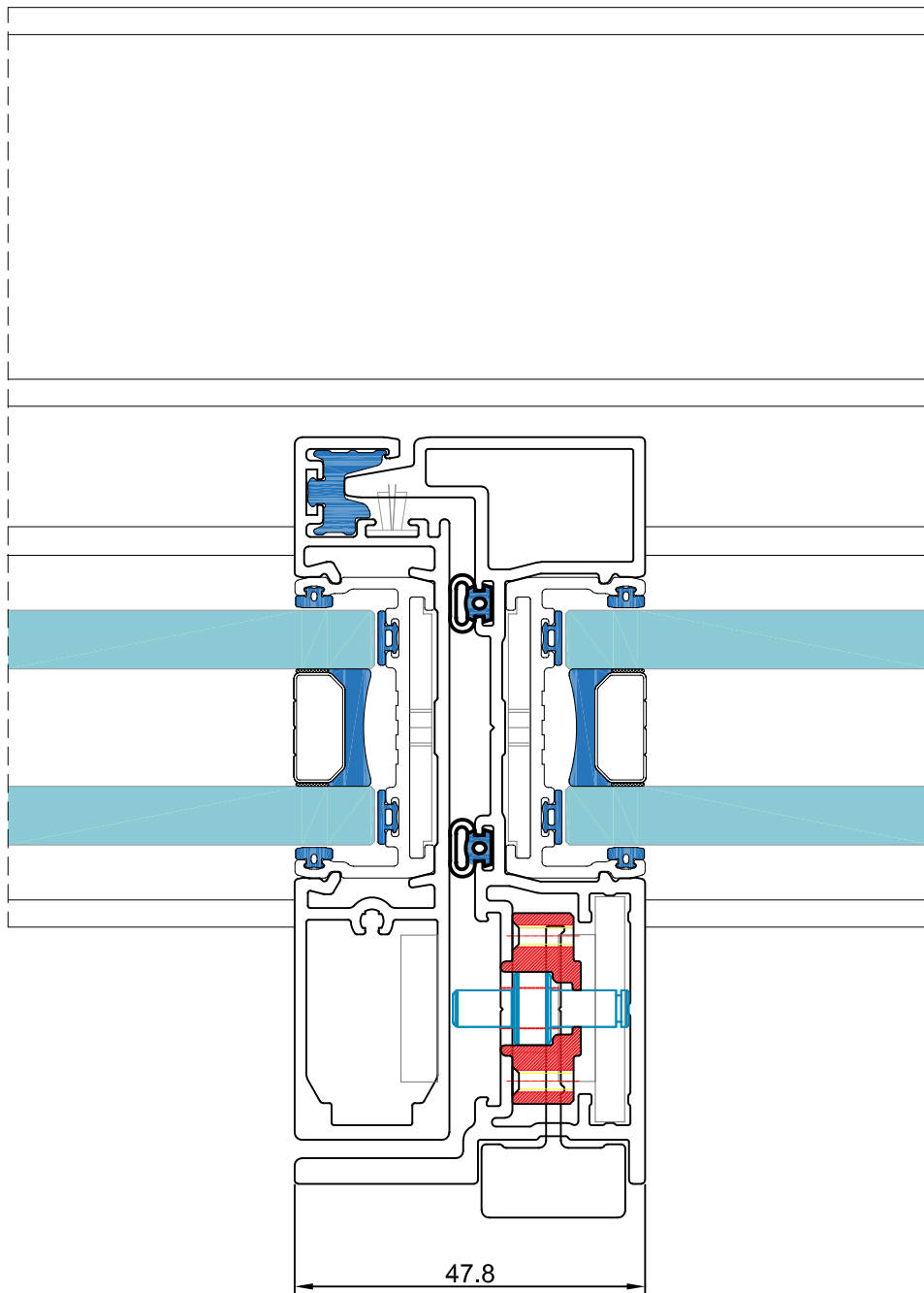

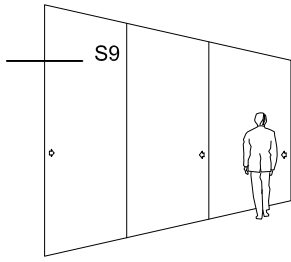

sección 9

QEXP-C ESTÁNDAR

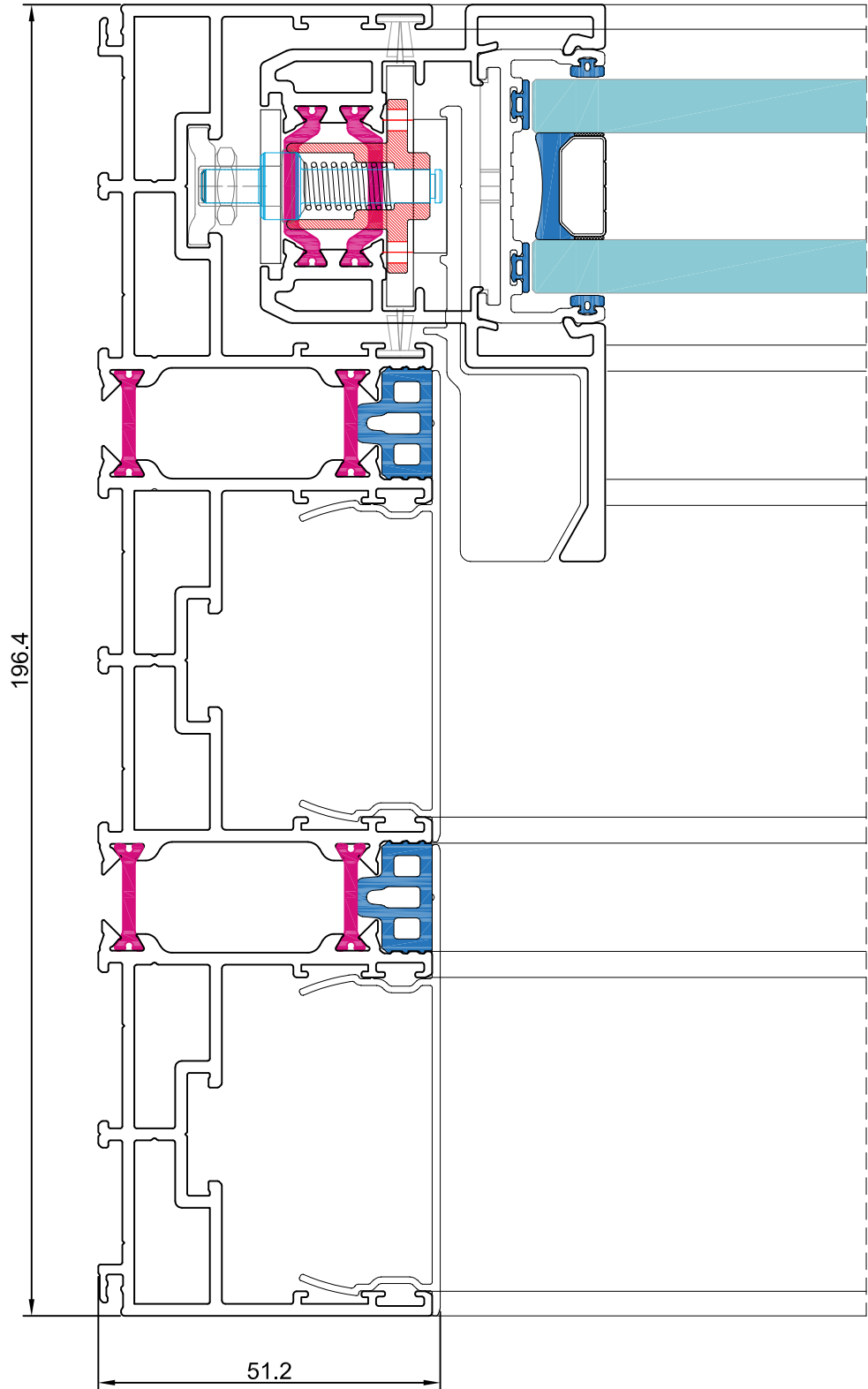

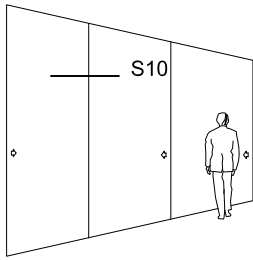

sección 10

QEXP-C ESTÁNDAR

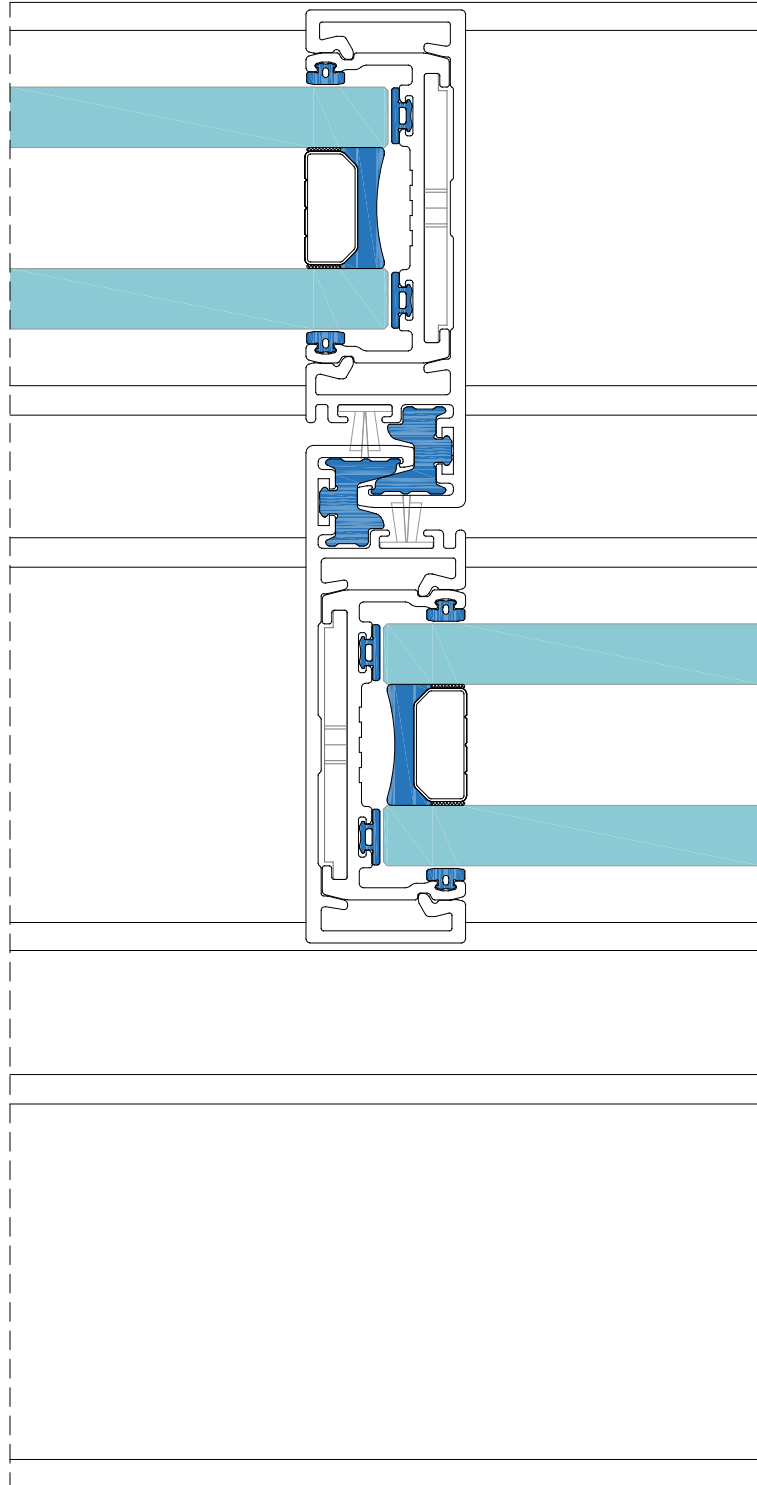

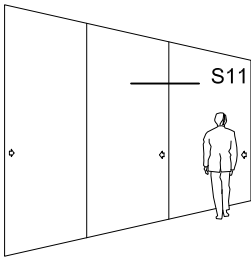

sección 11

QEXP-C ESTÁNDAR

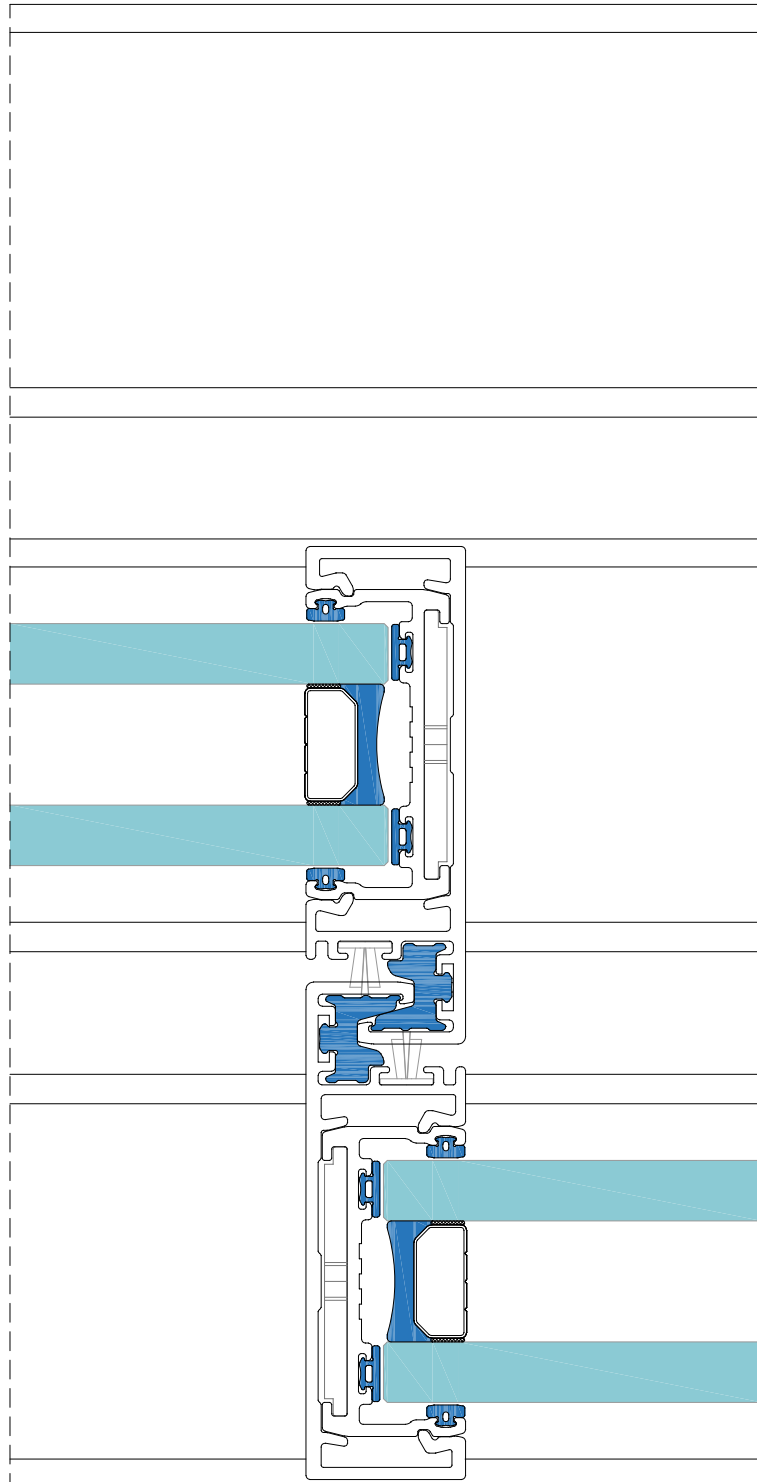

aluminio

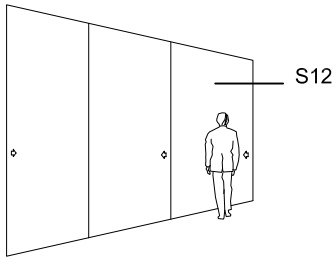

sección 12

QEXP-C ESTÁNDAR

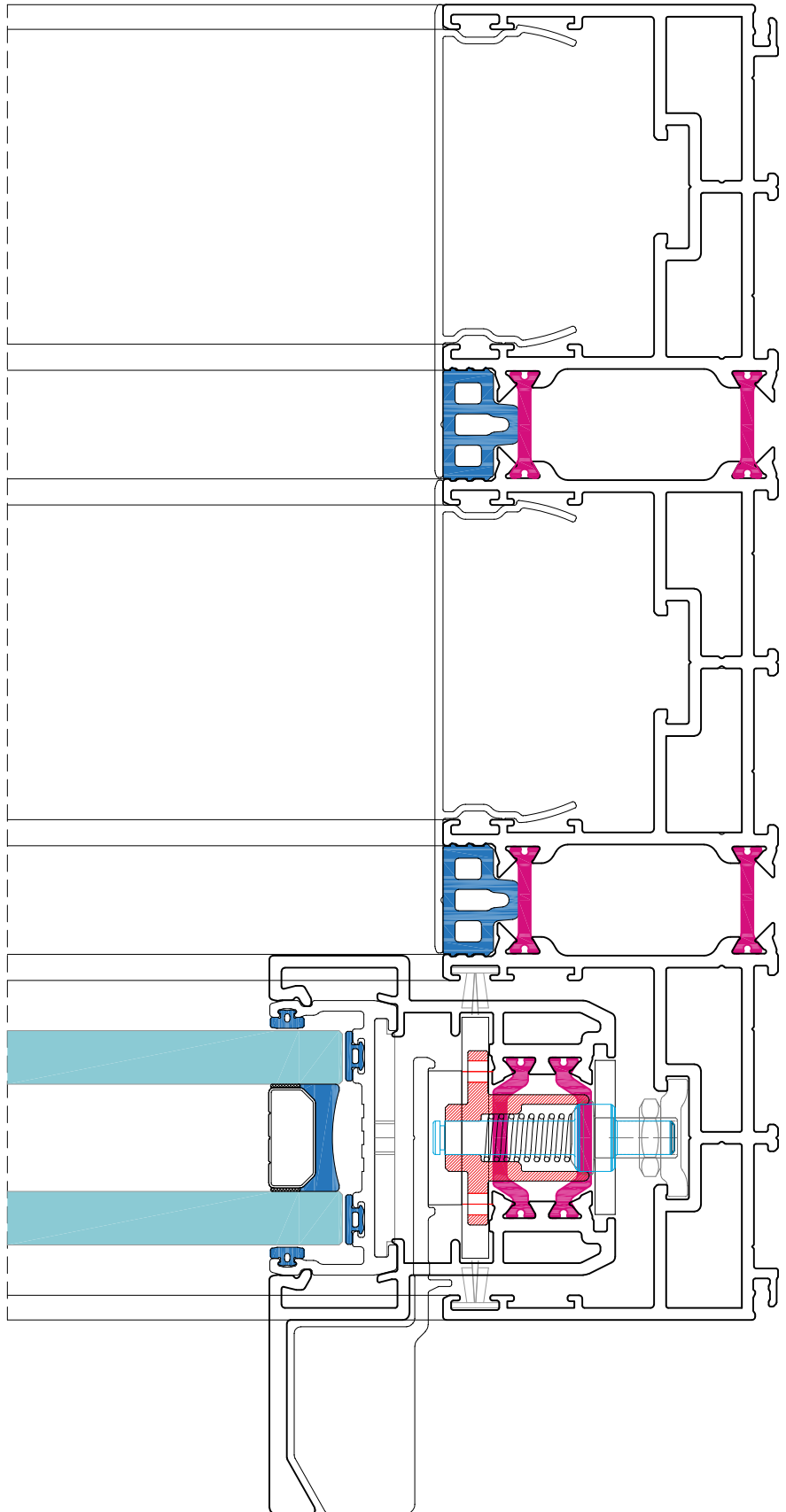

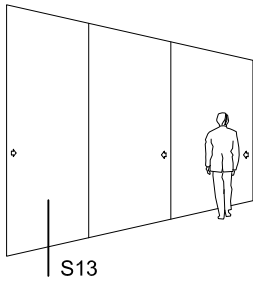

sección 13

QEXP-C ESTÁNDAR

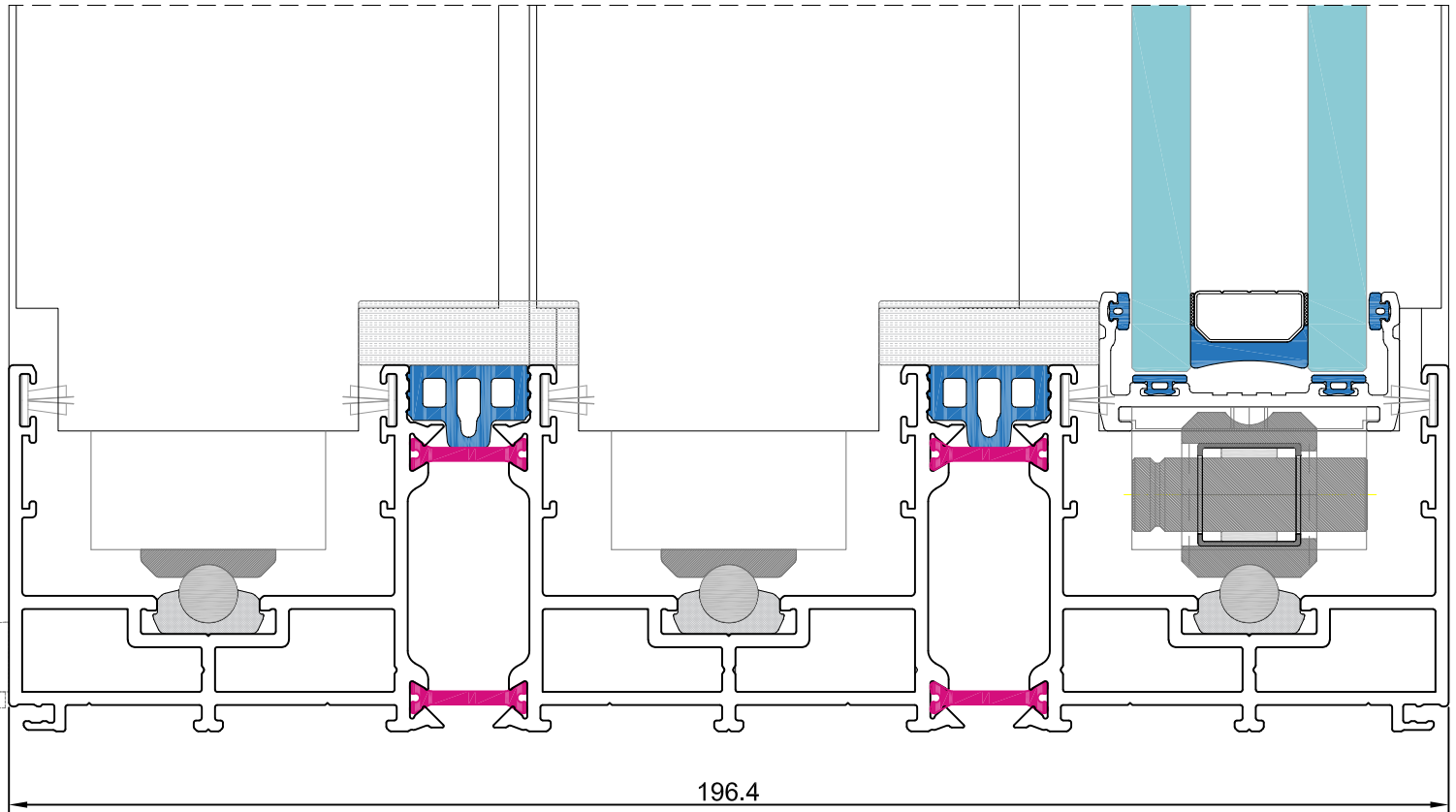

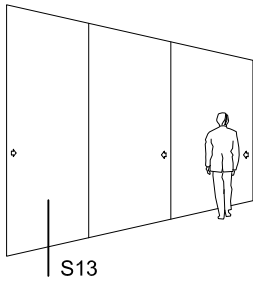

sección 13

QEXP-C ESTÁNDAR

opción SOLERA OCULTA

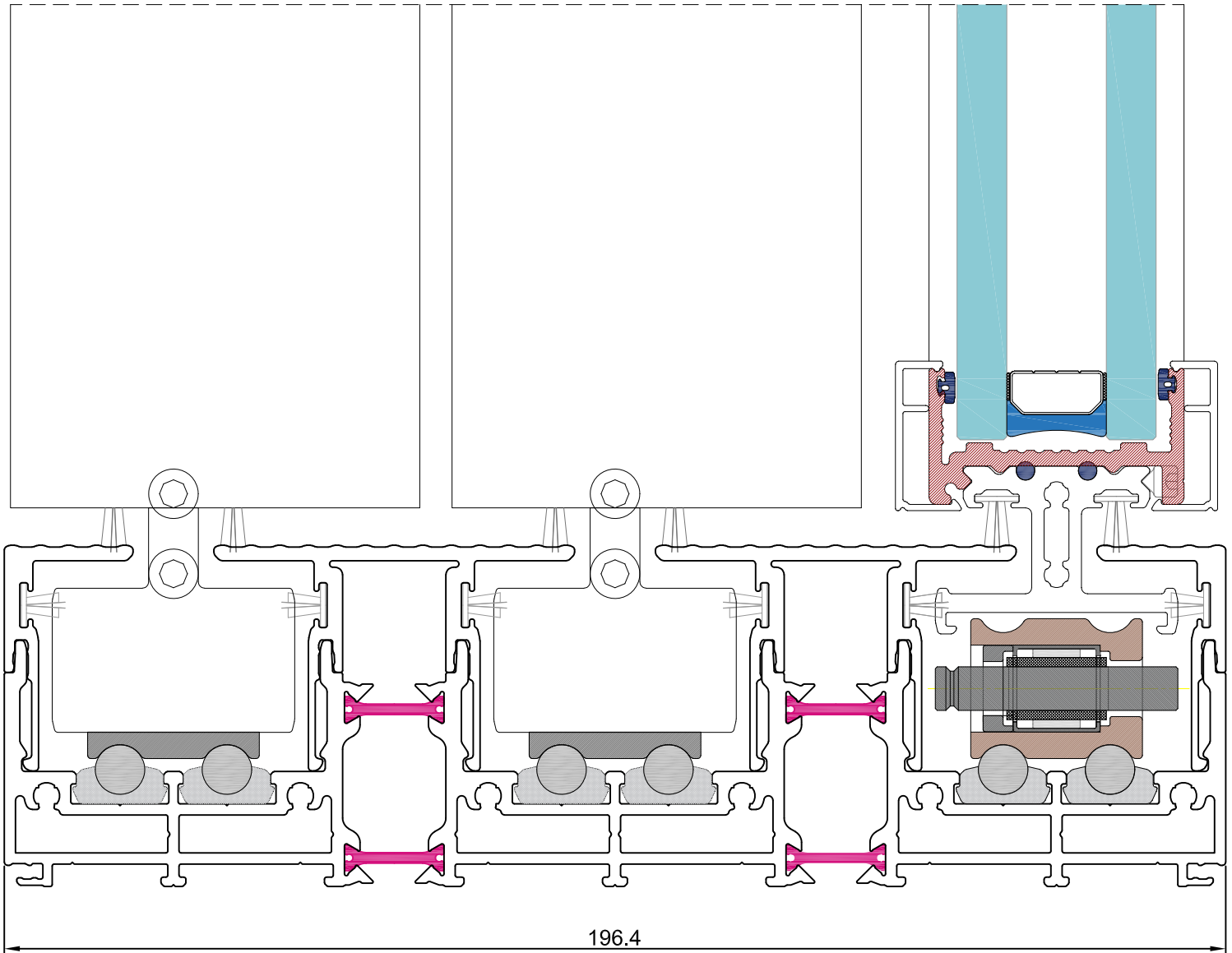

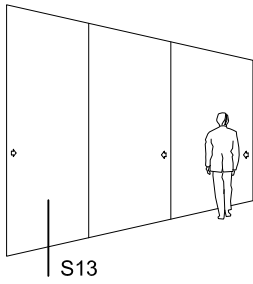

sección 13

QEXP-C ESTÁNDAR

opción SOLERA OCULTA

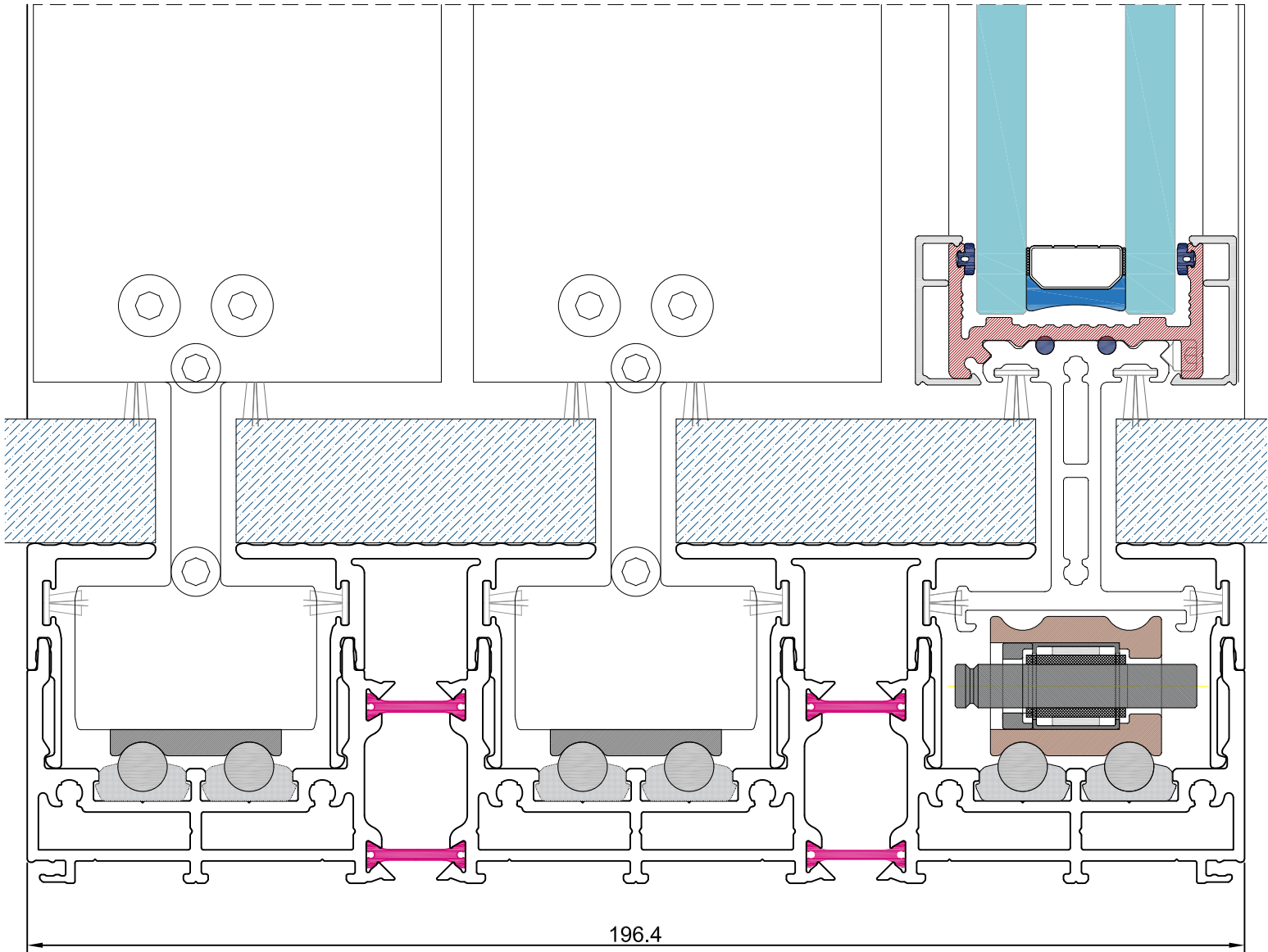

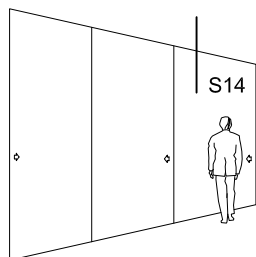

QEXP-C ESTÁNDAR

sección 14

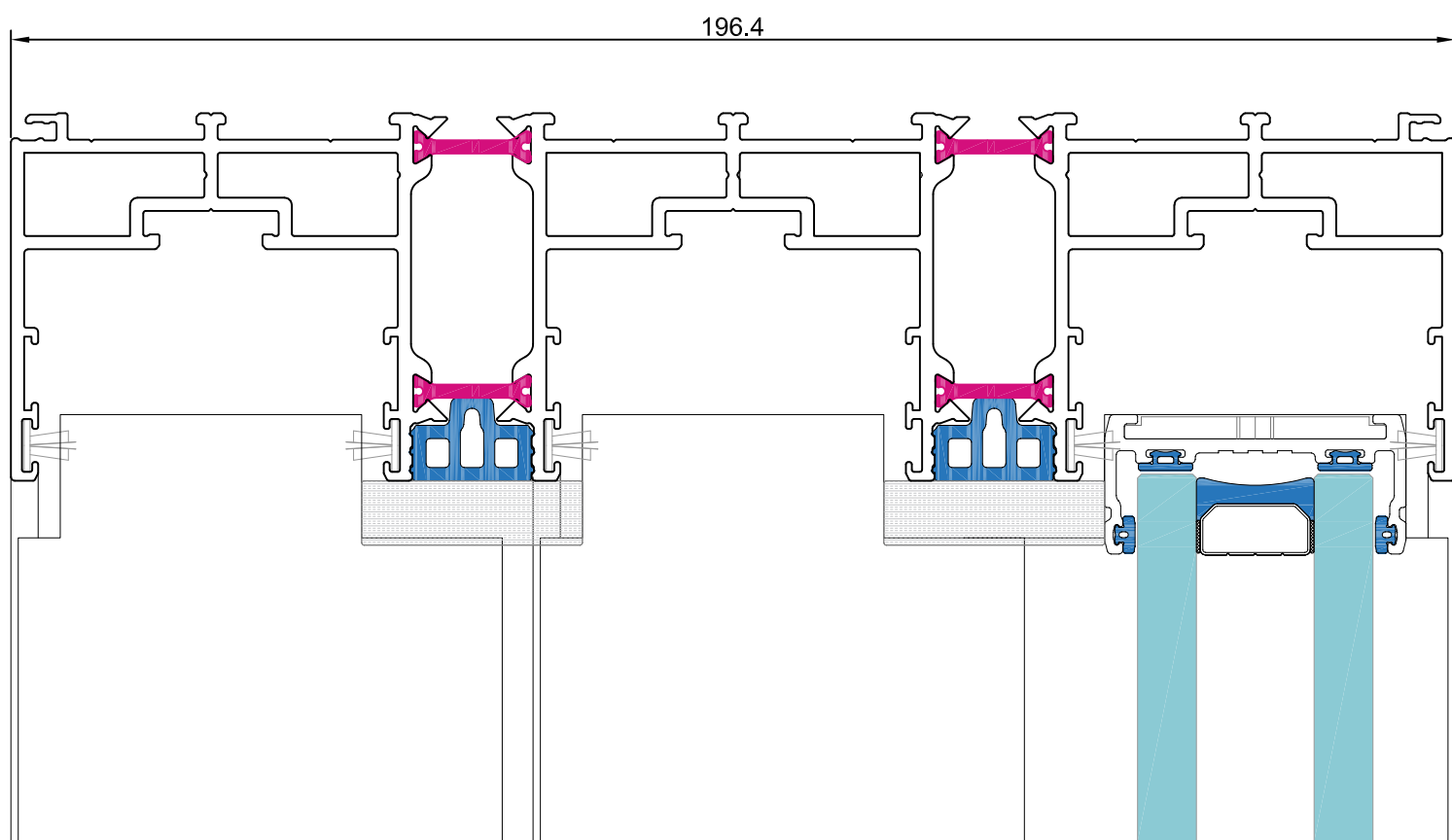

QEXP-C

POCKET

"Existencia de ..., o a veces tal vez no ..."

Cuando algo esencial necesita ser escondido por un momento, el sistema **QEXP-C POCKET** permite ocultar la ventana en cualquier "bolsillo" de su casa

aluminio

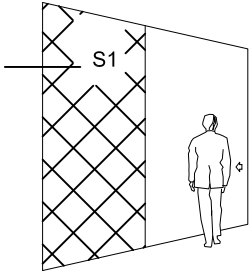

sección 1

QEXP-C POCKET

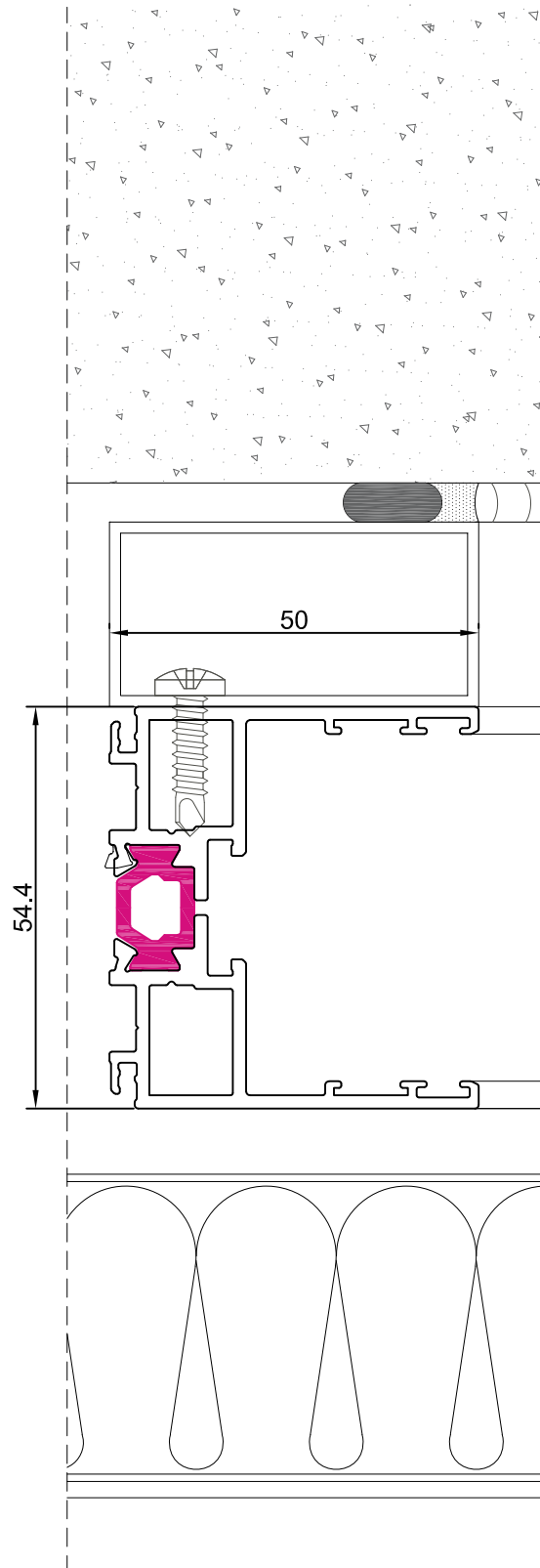

aluminio

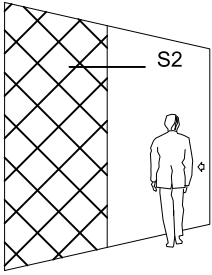

sección 2

QEXP-C POCKET

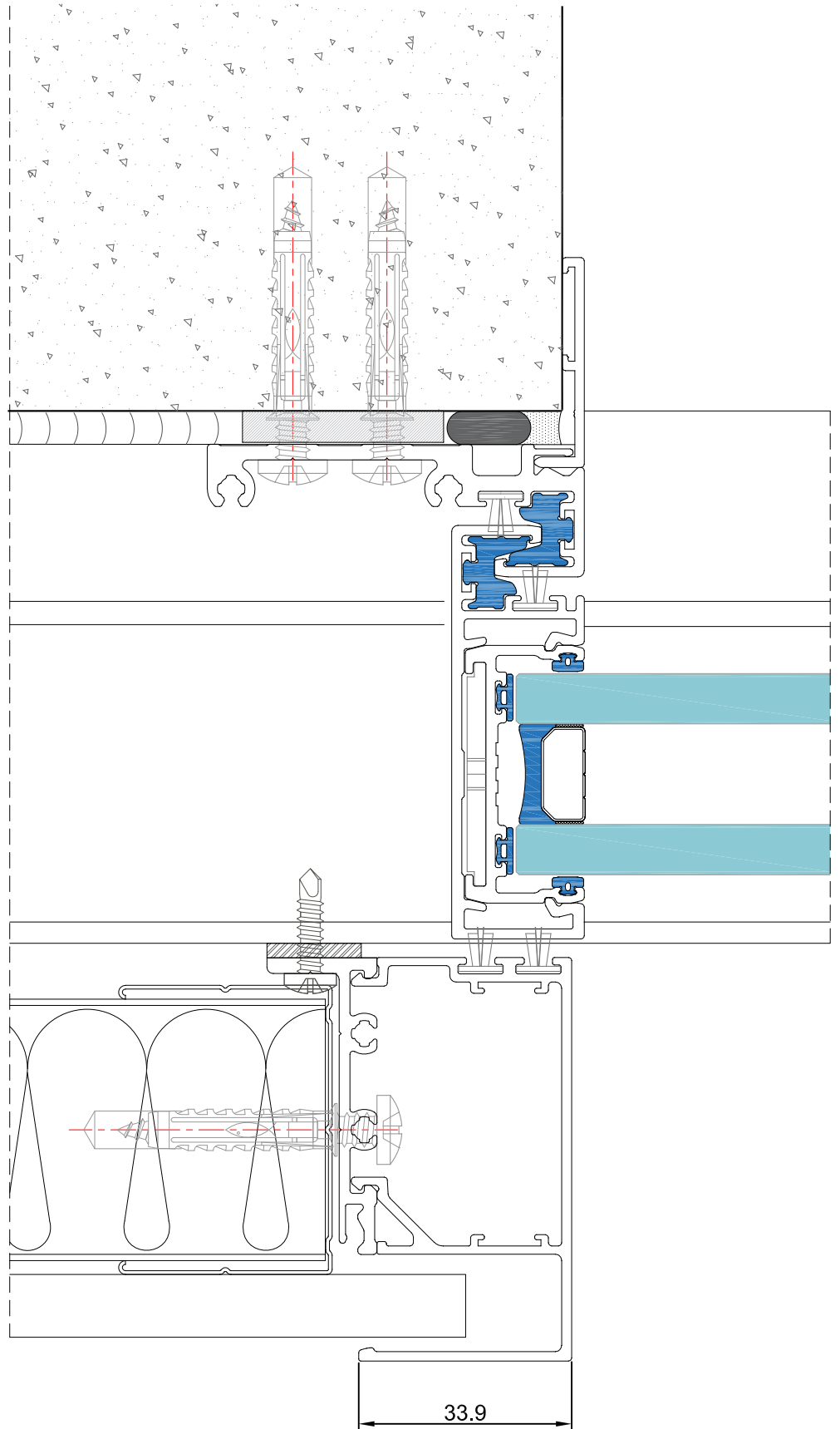

aluminio

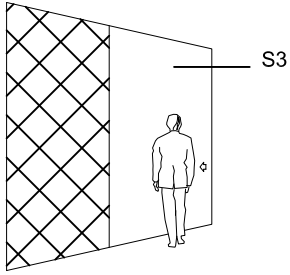

QEXP-C POCKET

sección 3

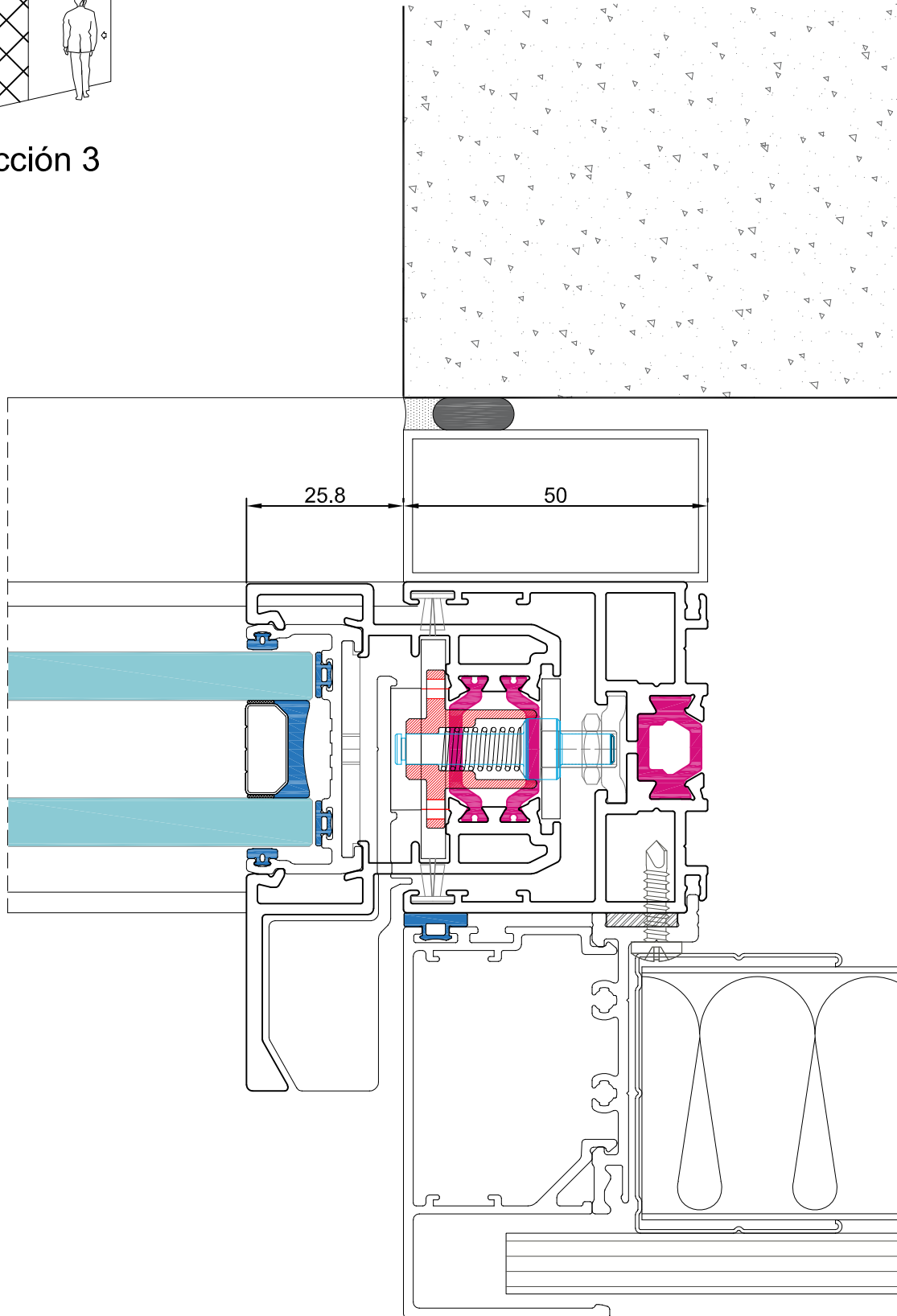

aluminio

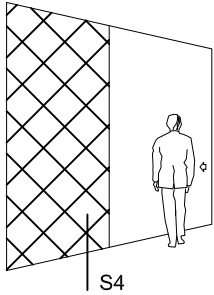

sección 4

QEXP-C POCKET

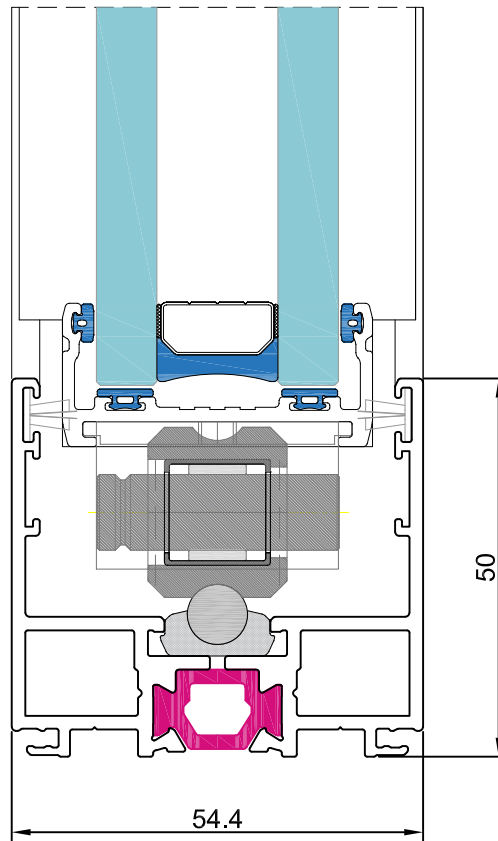

aluminio

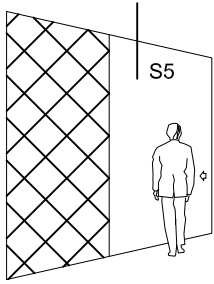

QEXP-C POCKET

sección 5

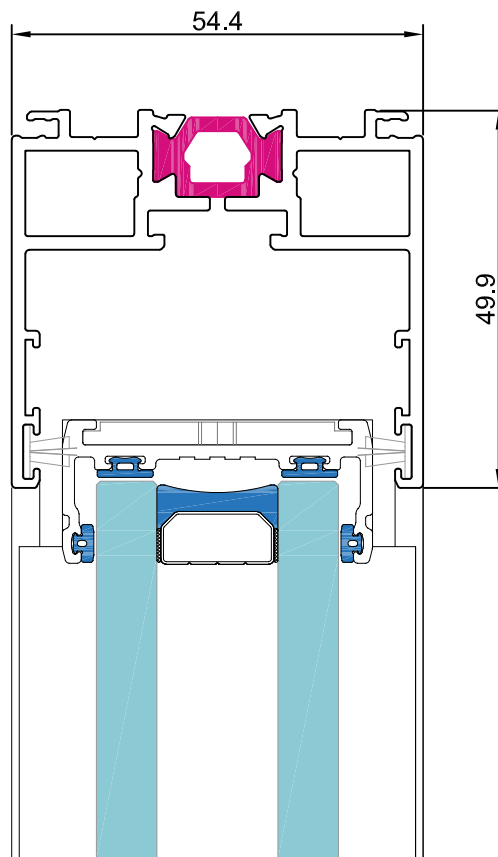

aluminio

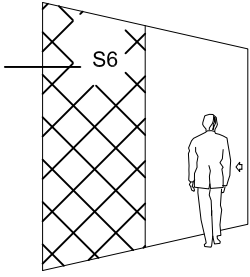

sección 6

QEXP-C POCKET

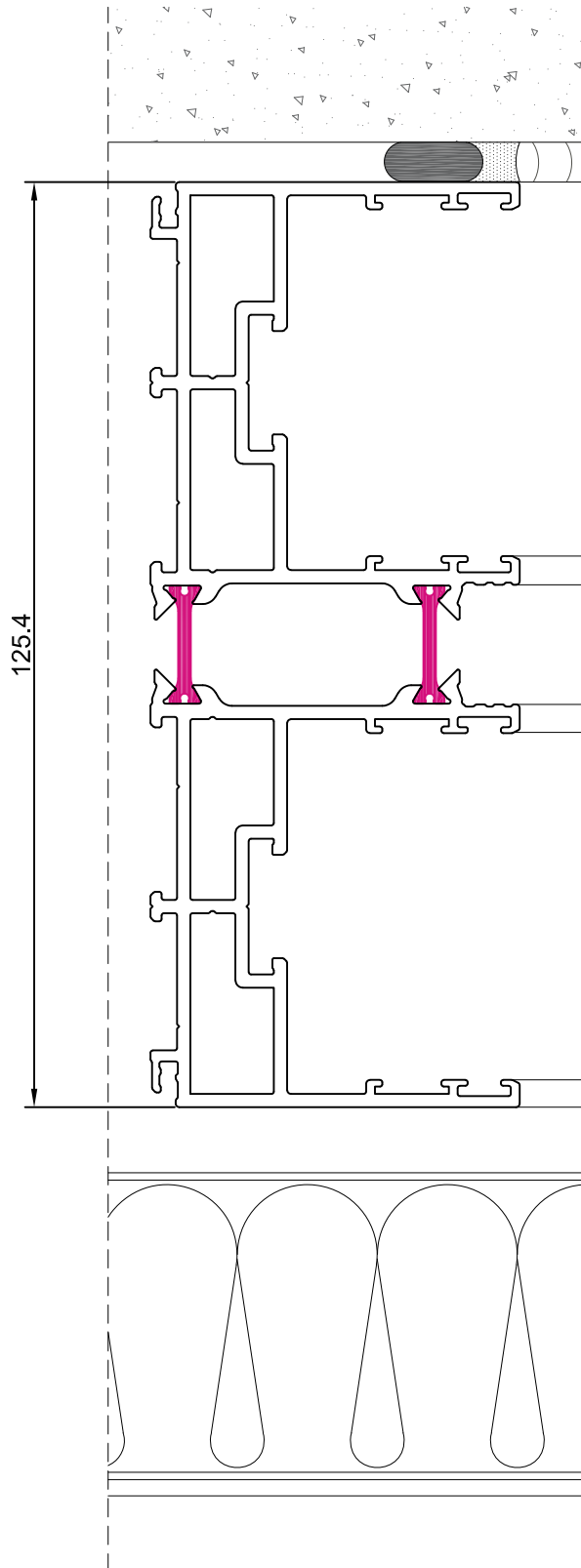

aluminio

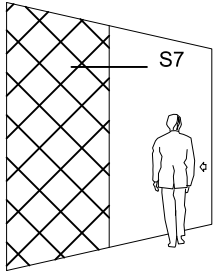

sección 7

QEXP-C POCKET

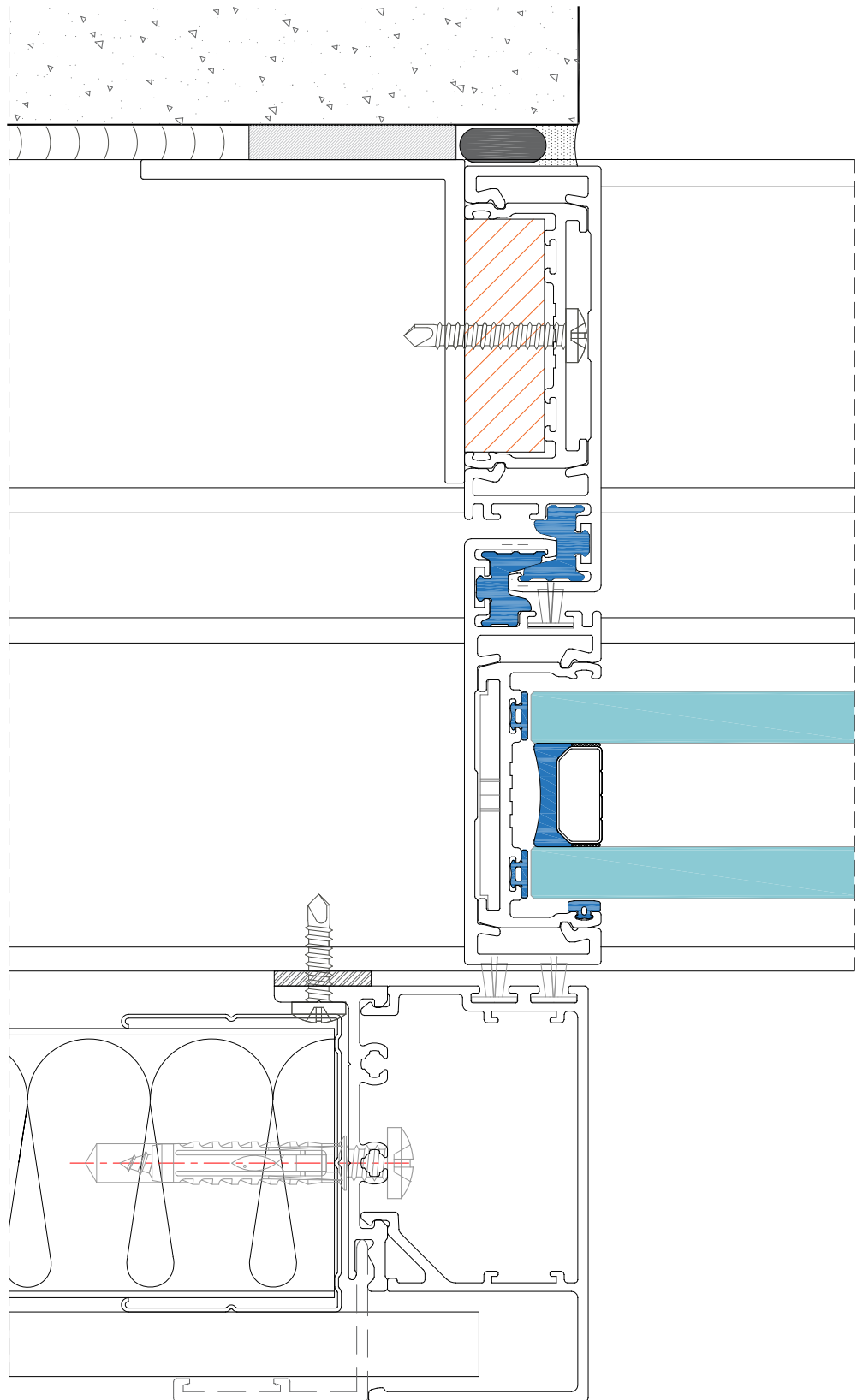

aluminio

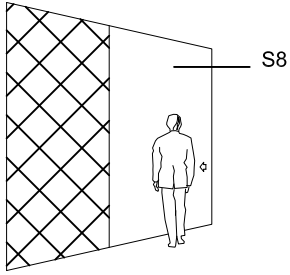

QEXP-C POCKET

sección 8

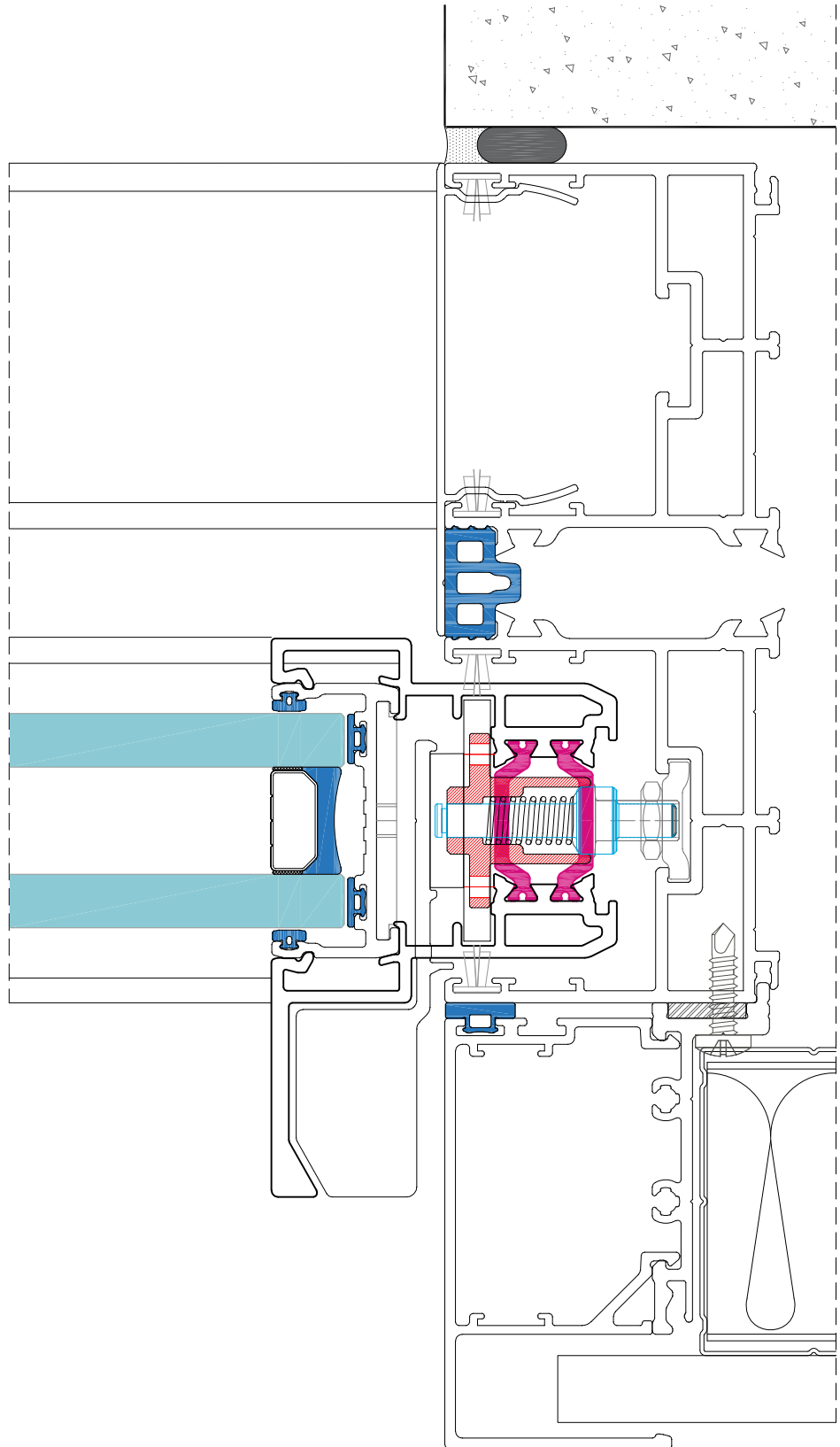

aluminio

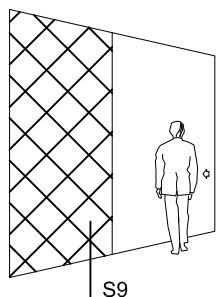

sección 9

QEXP-C POCKET

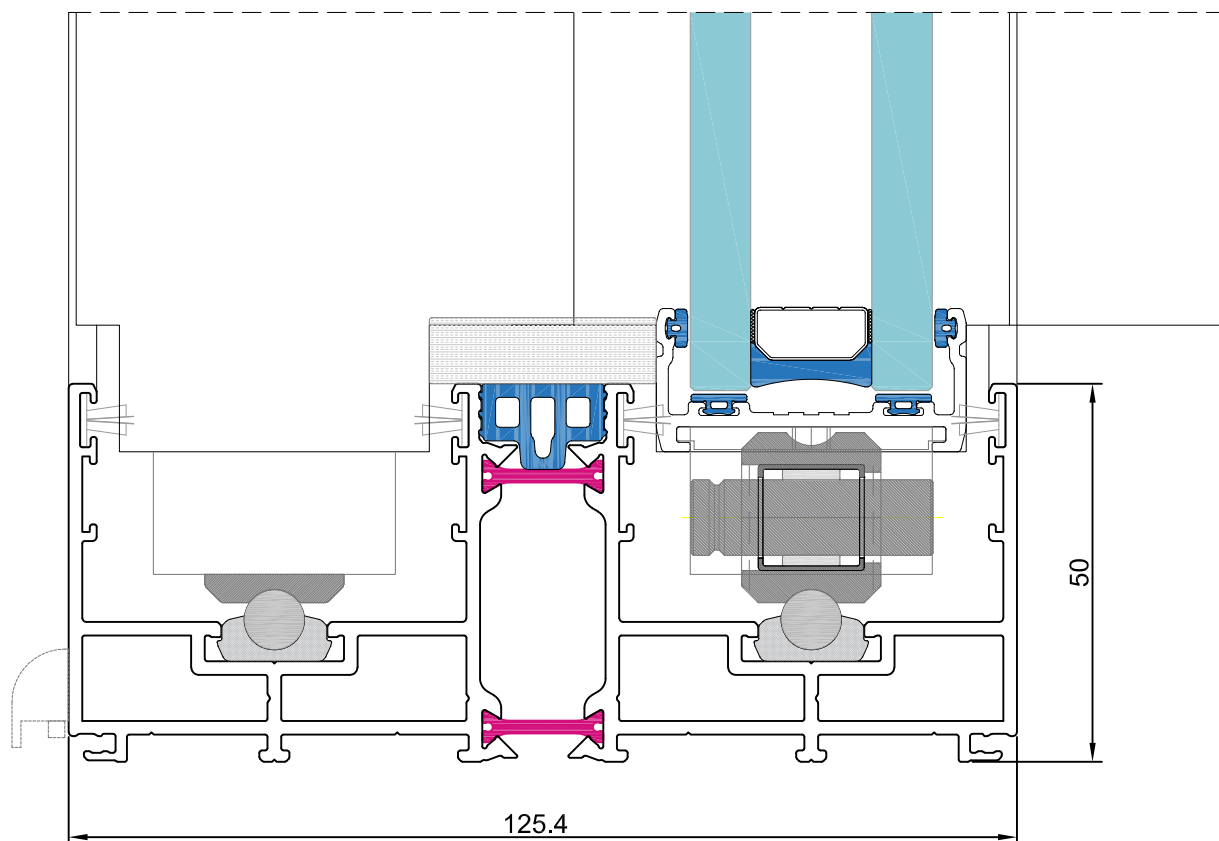

aluminio

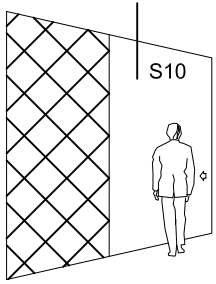

QEXP-C POCKET

sección 10

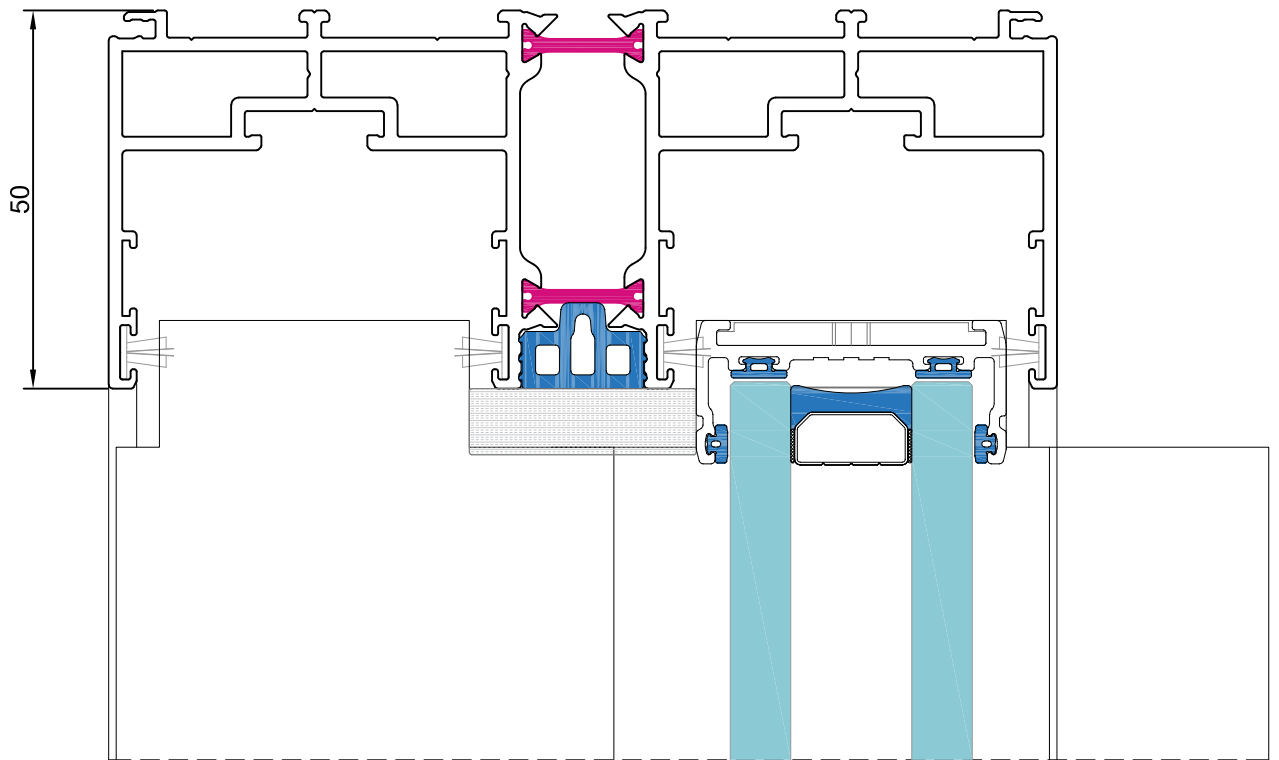

aluminio

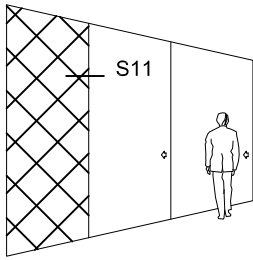

sección 11

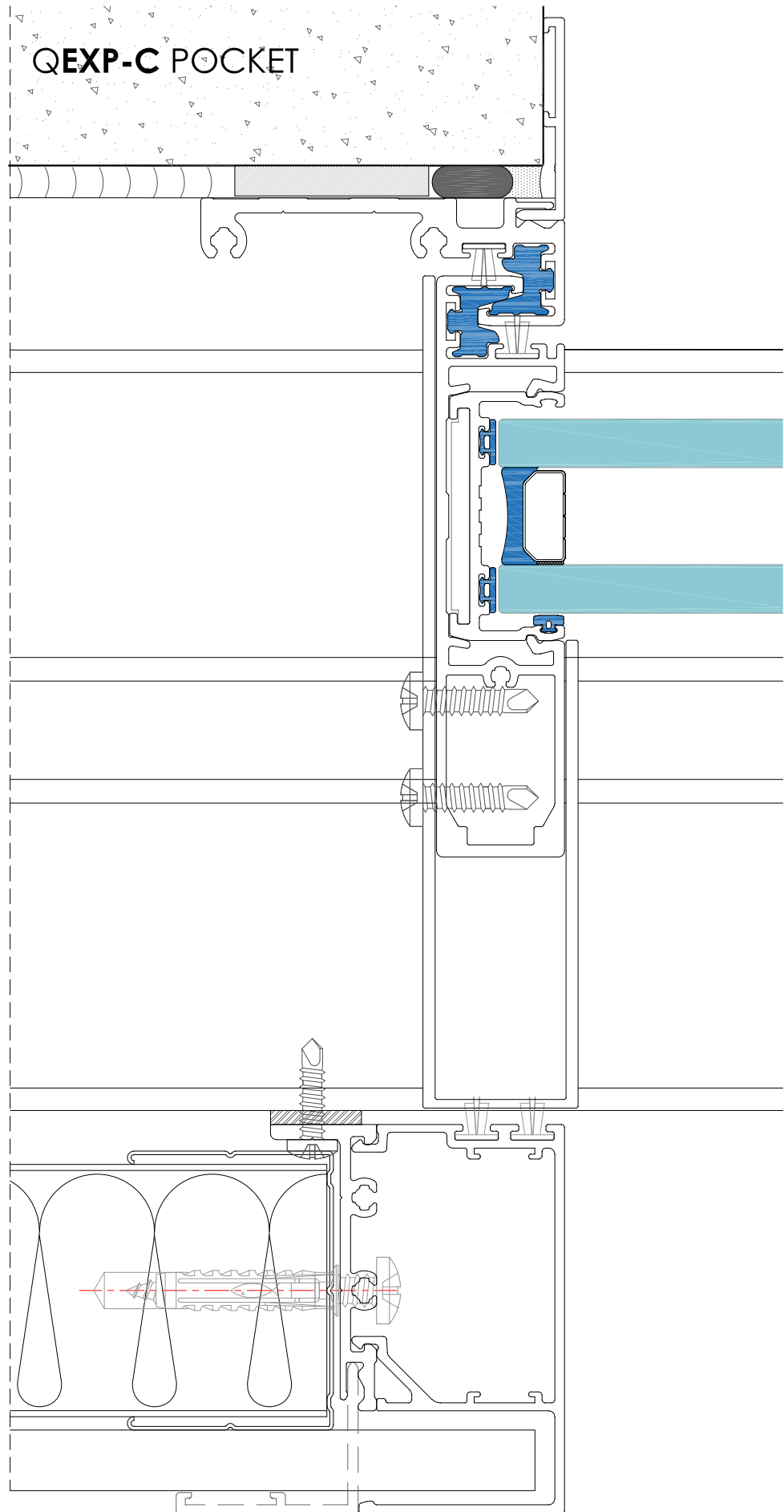

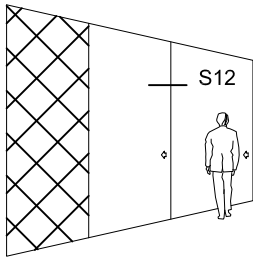

sección 12

QEXP-C POCKET

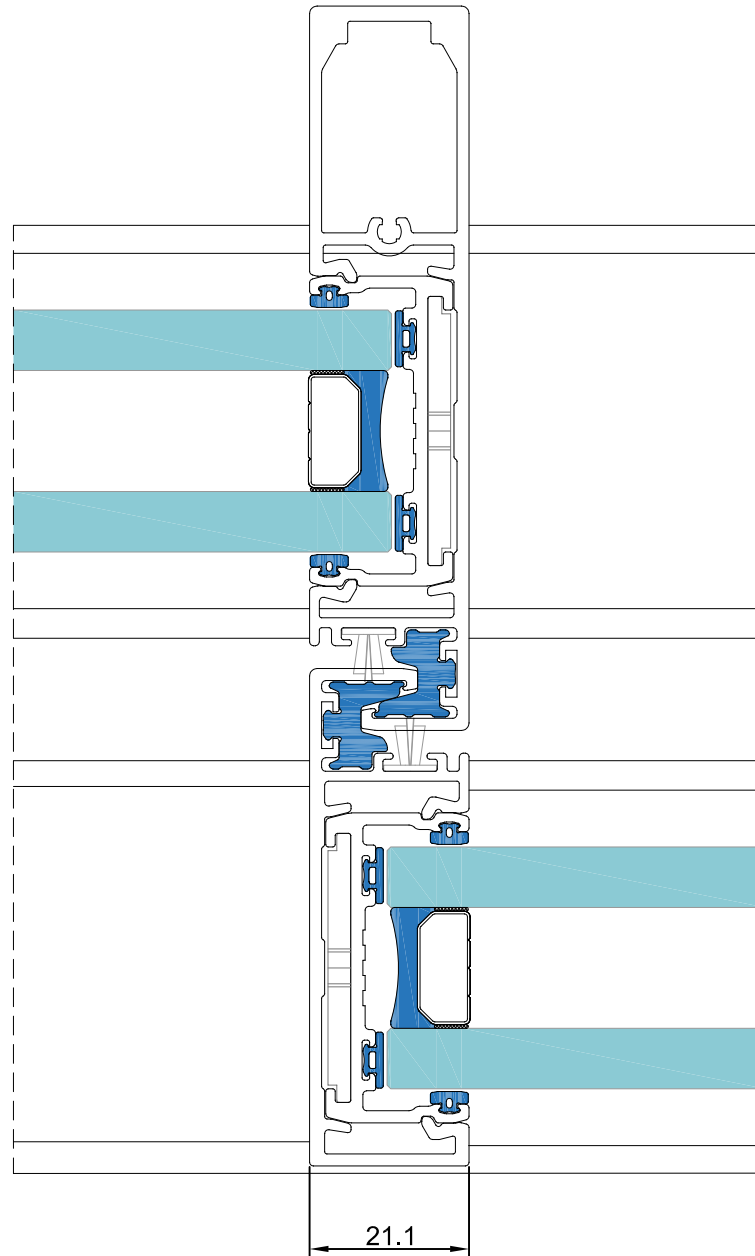

aluminio

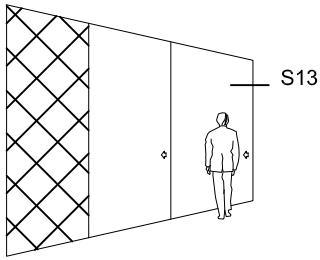

sección 13

QEXP-C POCKET

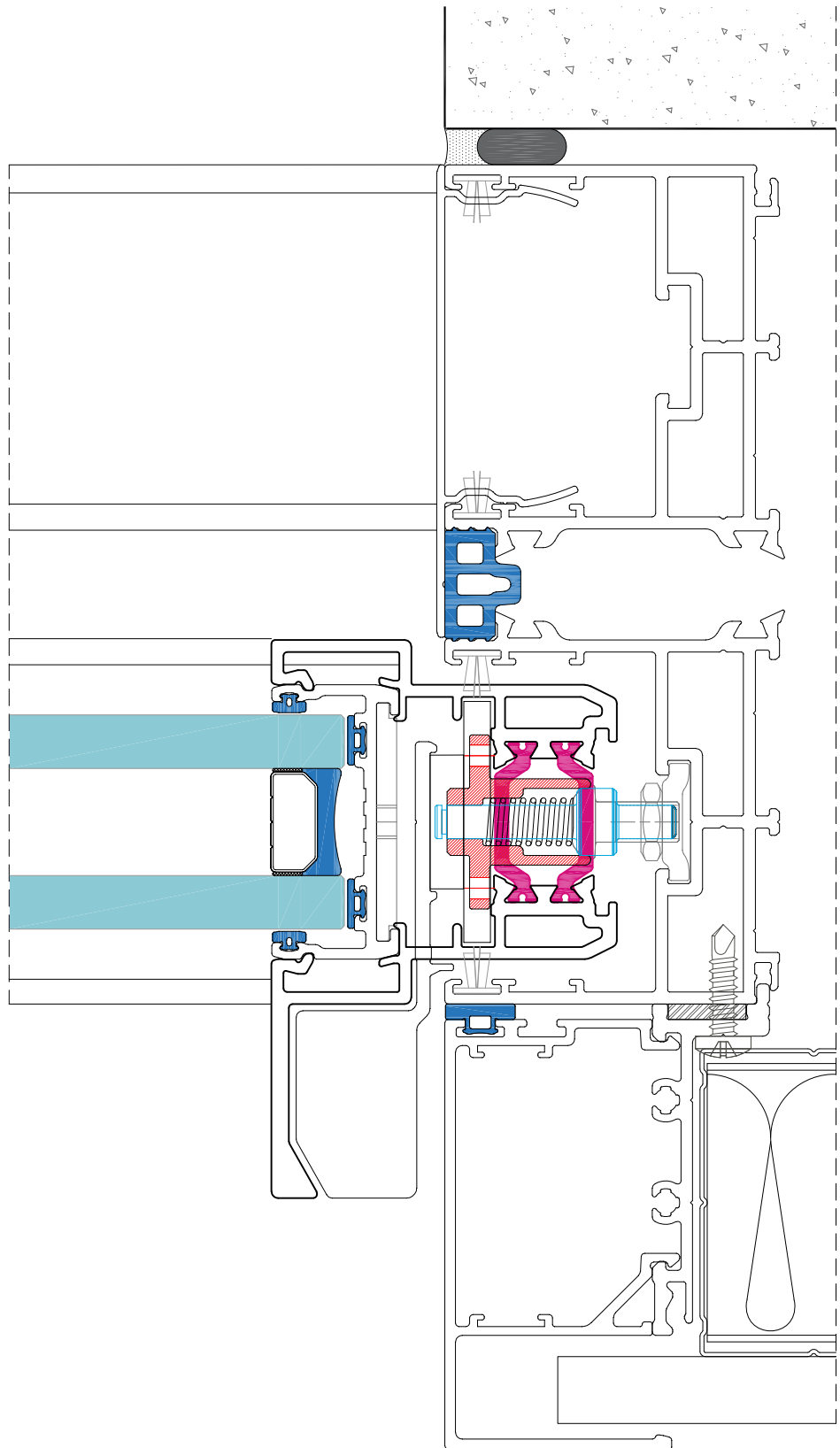

QEXP-C

CORNER

"La amplitud de la inexistencia"

El sistema **QEXP-C CORNER** elimina de las esquinas de vidrio las pesadas piezas estructurales opacas, ofreciendo la vista del paisaje circundante totalmente libre de obstáculos.

Además la posibilidad de su apertura permite la libertad de movimientos, pero no de forma sólo conceptual si no de forma física.

aluminio

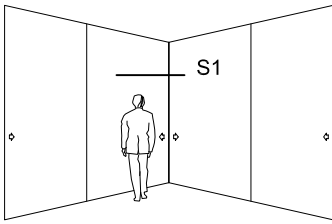

QEXP-C CORNER

opción esquina perfil visto

sección 1

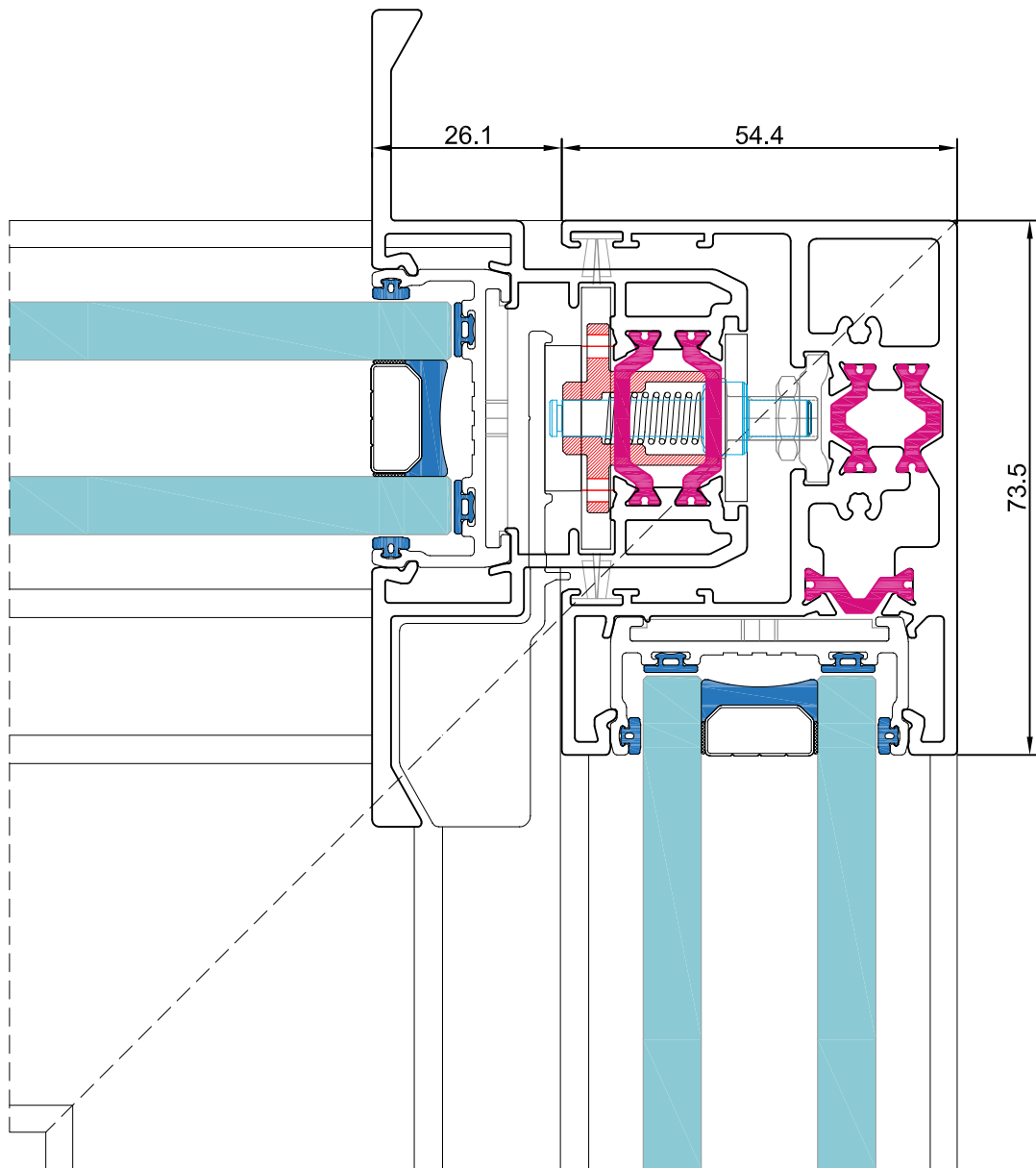

aluminio

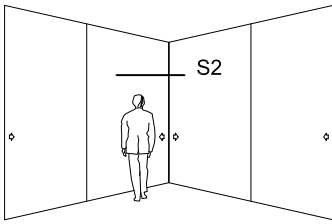

QEXP-C CORNER

opción esquina perfil oculto

sección 2

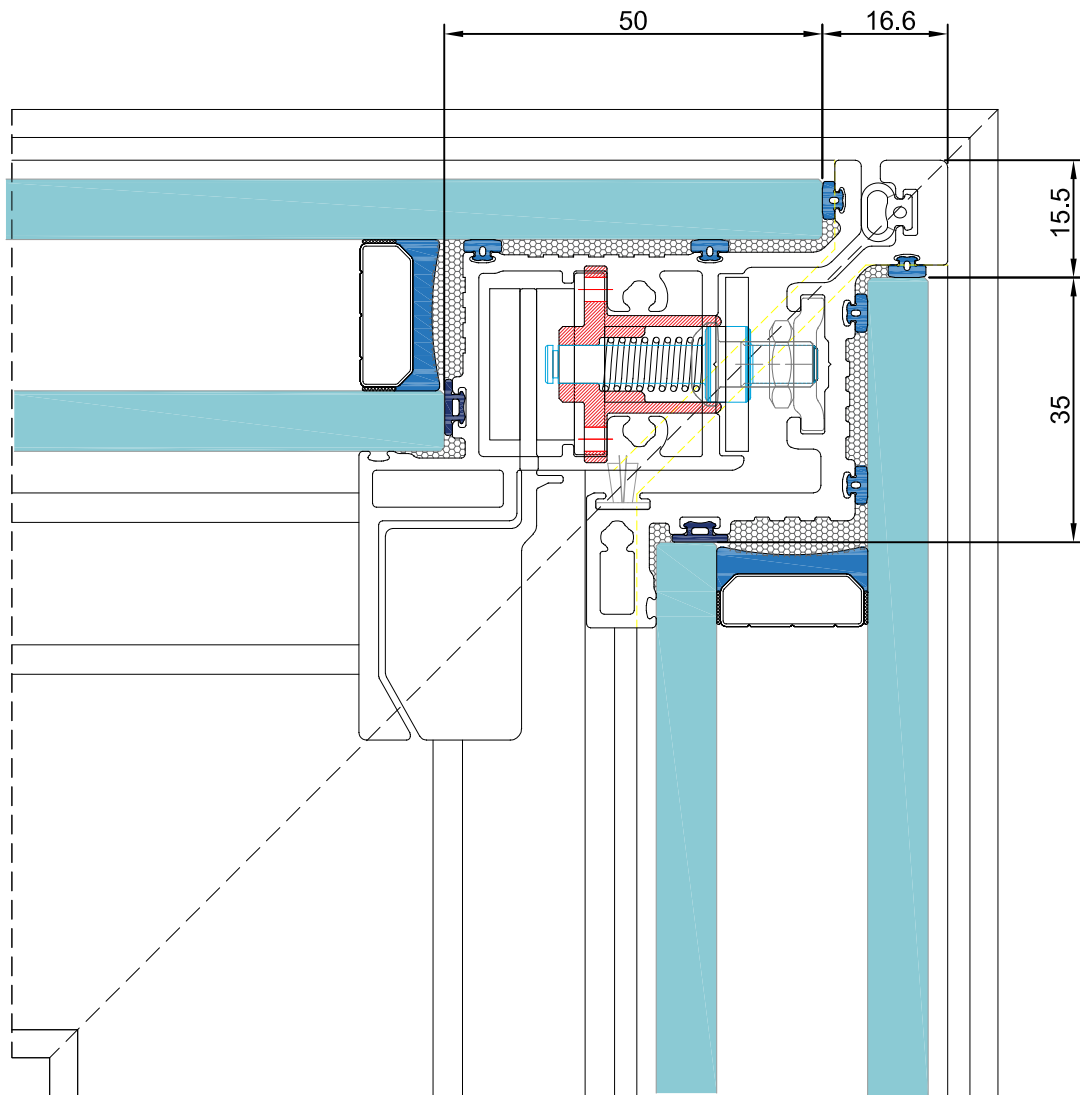

QEXP-C

MOSQUITO

"Paisajes idílicos, olores a jazmín,
temperaturas suaves, una brisa refrescante y ..."

Aproveche toda la interacción
del sistema EXPansión, el cual
permite que la propia envolvente
sea su refugio, evitando la incomodidad
de la aparición de insectos desagradables.

El sistema **QEXP-C MOSQUITO**
permite la colocación de una red translúcida
que sirve de barrera "anti-mosquito"

aluminio

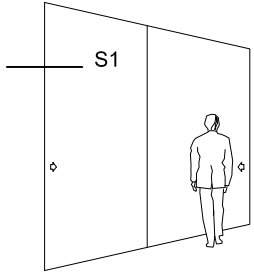

sección 1

QEXP-C MOSQUITO

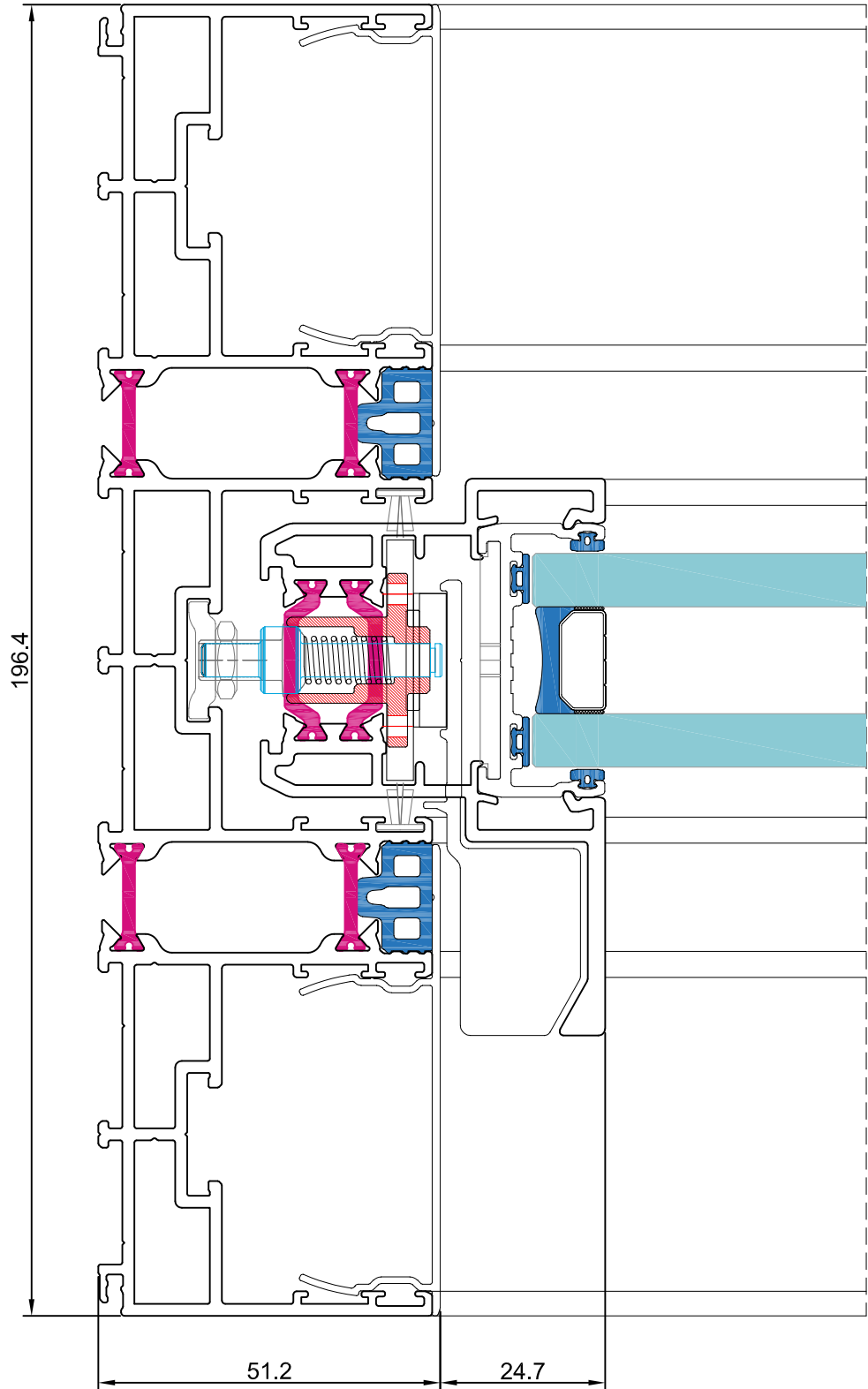

aluminio

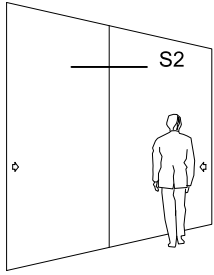

sección 2

QEXP-C MOSQUITO

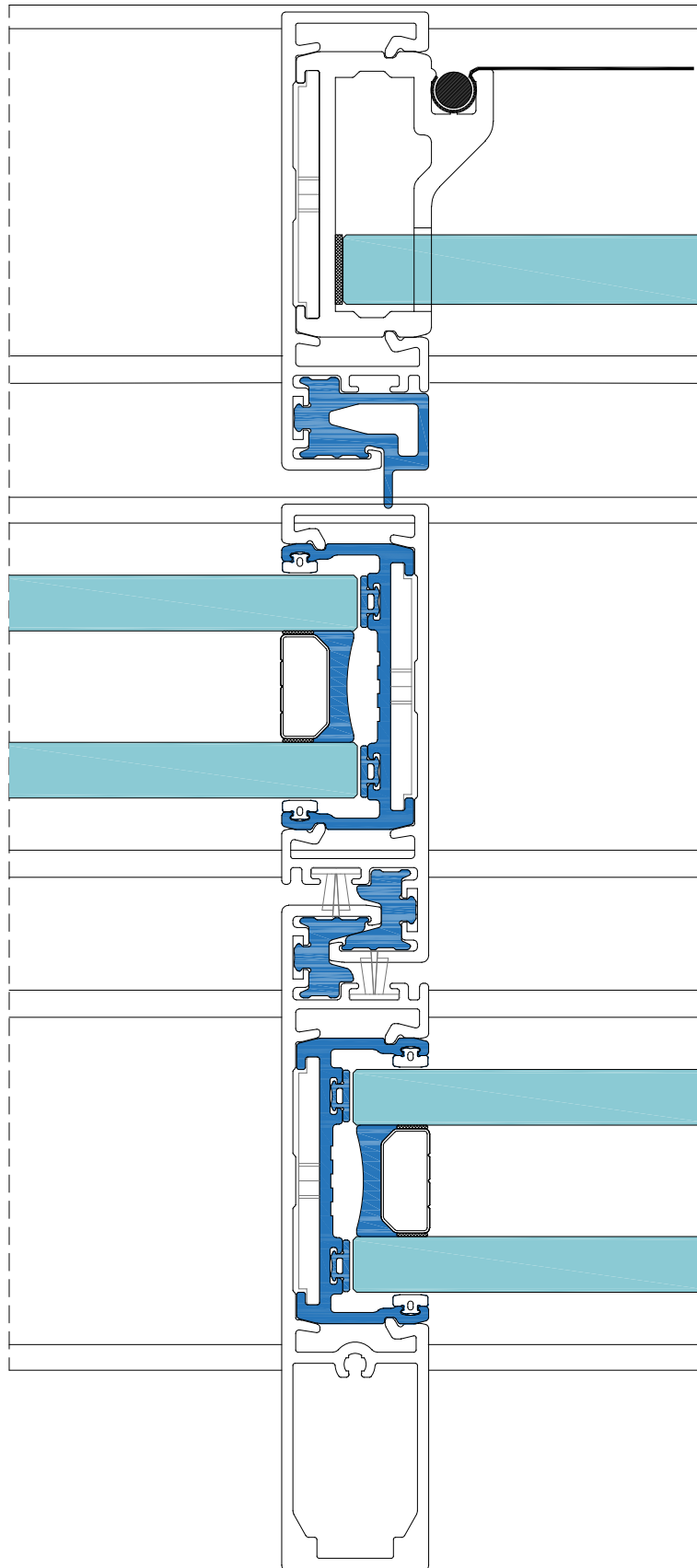

aluminio

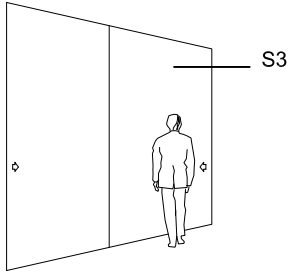

sección 3

QEXP-C MOSQUITO

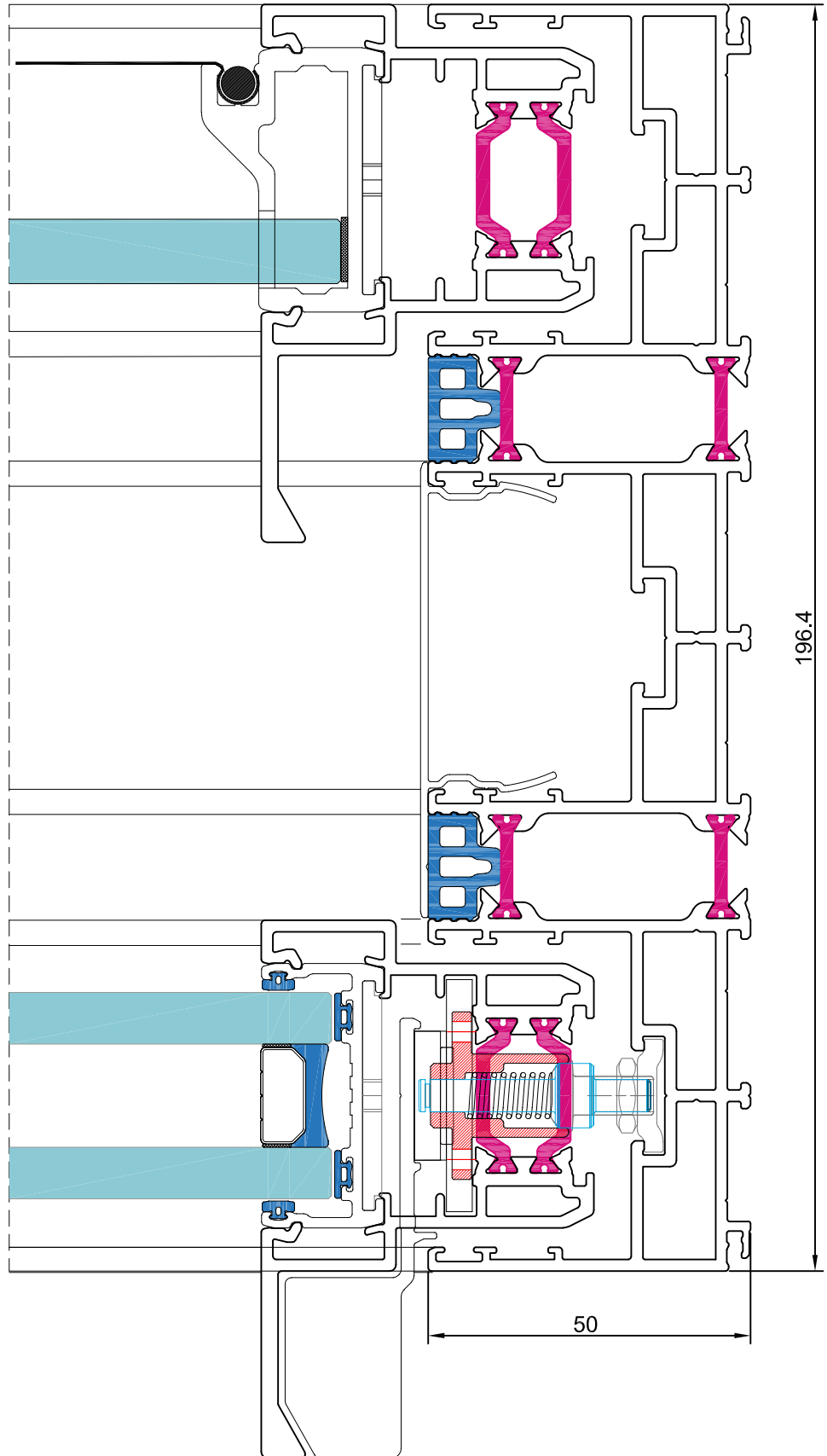

aluminio

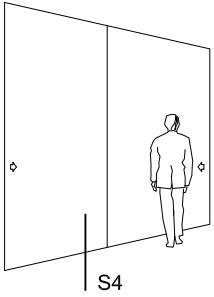

sección 4

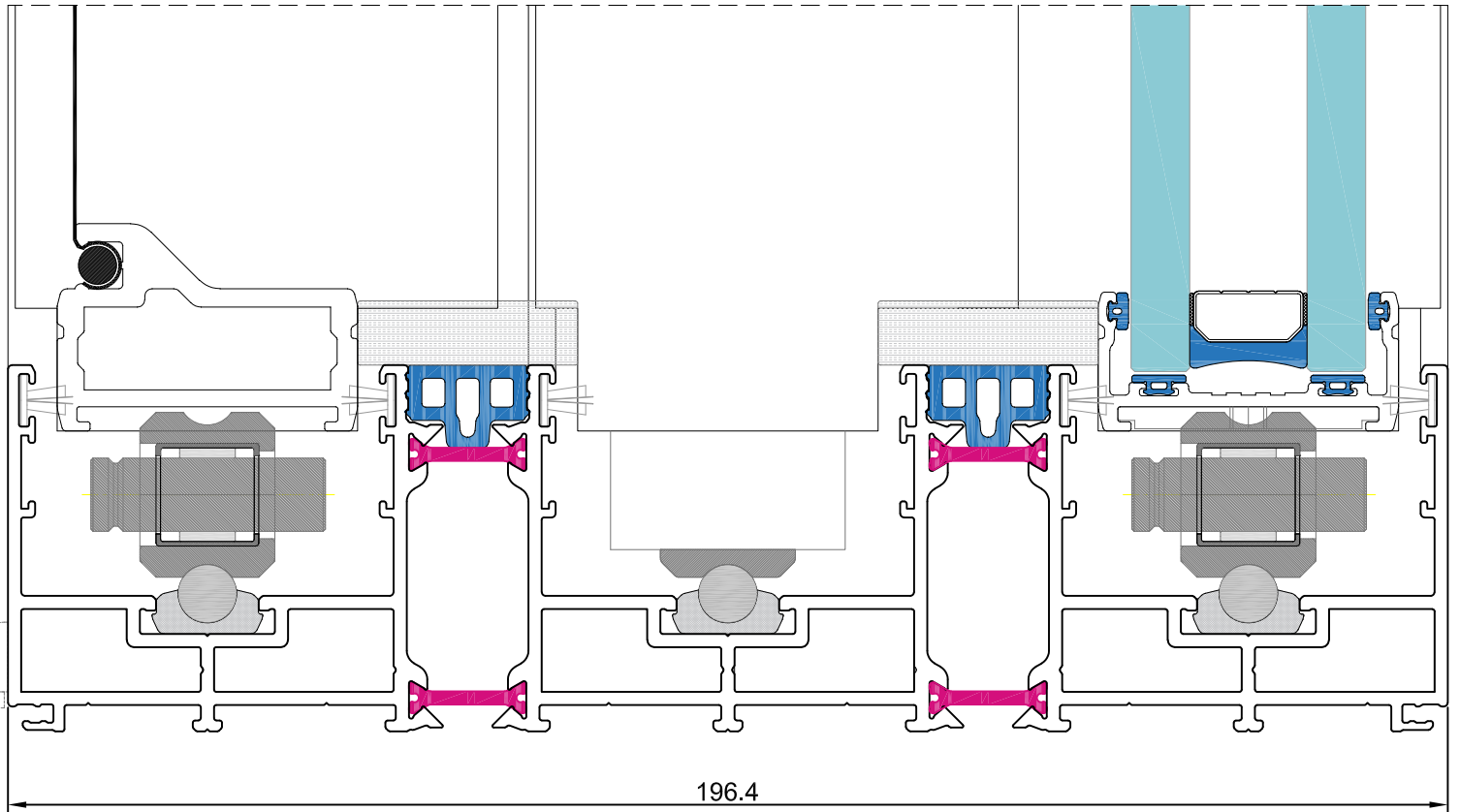

aluminio

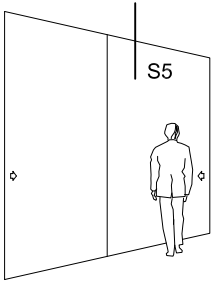

sección 5

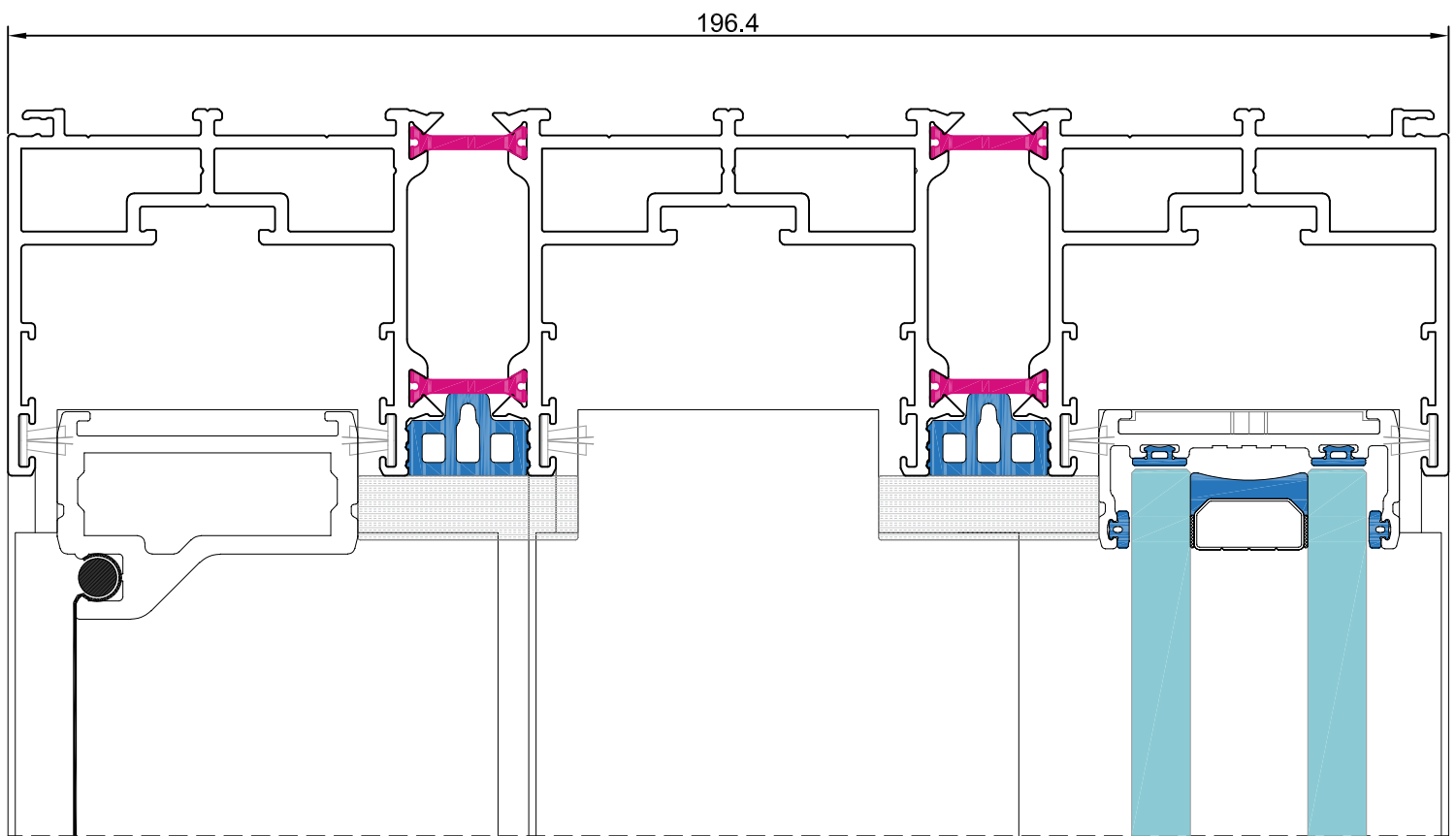

QEXP-G

GUILLOTINA

"¿Sólo en horizontal? No, también en vertical"

La diferencia y la audacia en contra de lo natural e incluso de la gravedad.

La apertura proporcionada por el sistema **QEXP-G GUILLOTINA** permite la plena apertura de los espacios, eliminando todas las fronteras entre lo interior y lo exterior

aluminio

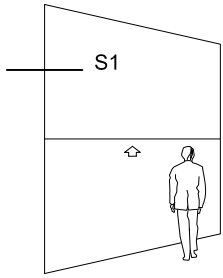

QEXP-G GUILLOTINA

sección 1

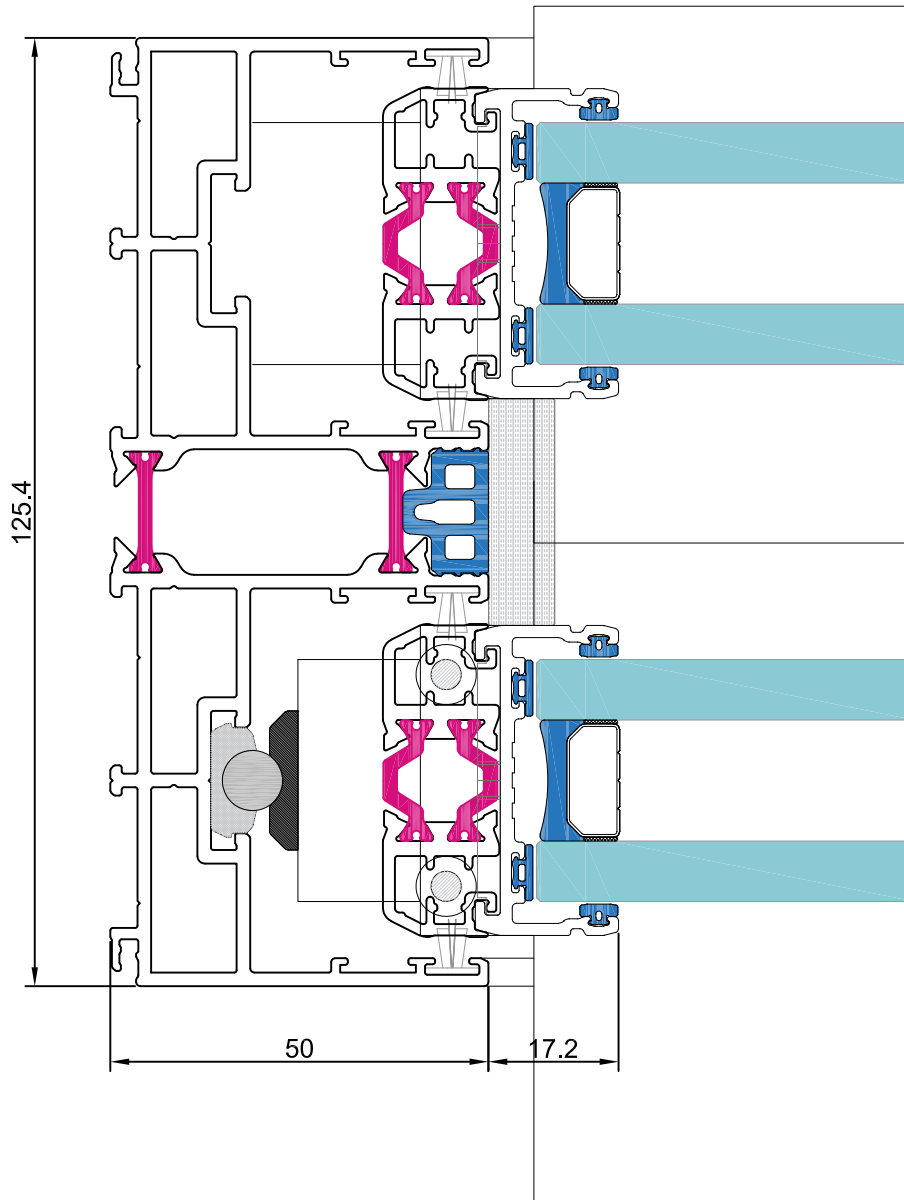

aluminio

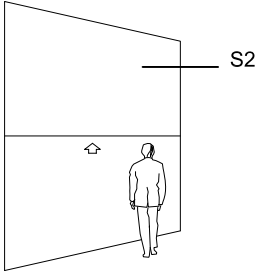

QEXP-G GUILLOTINA

sección 2

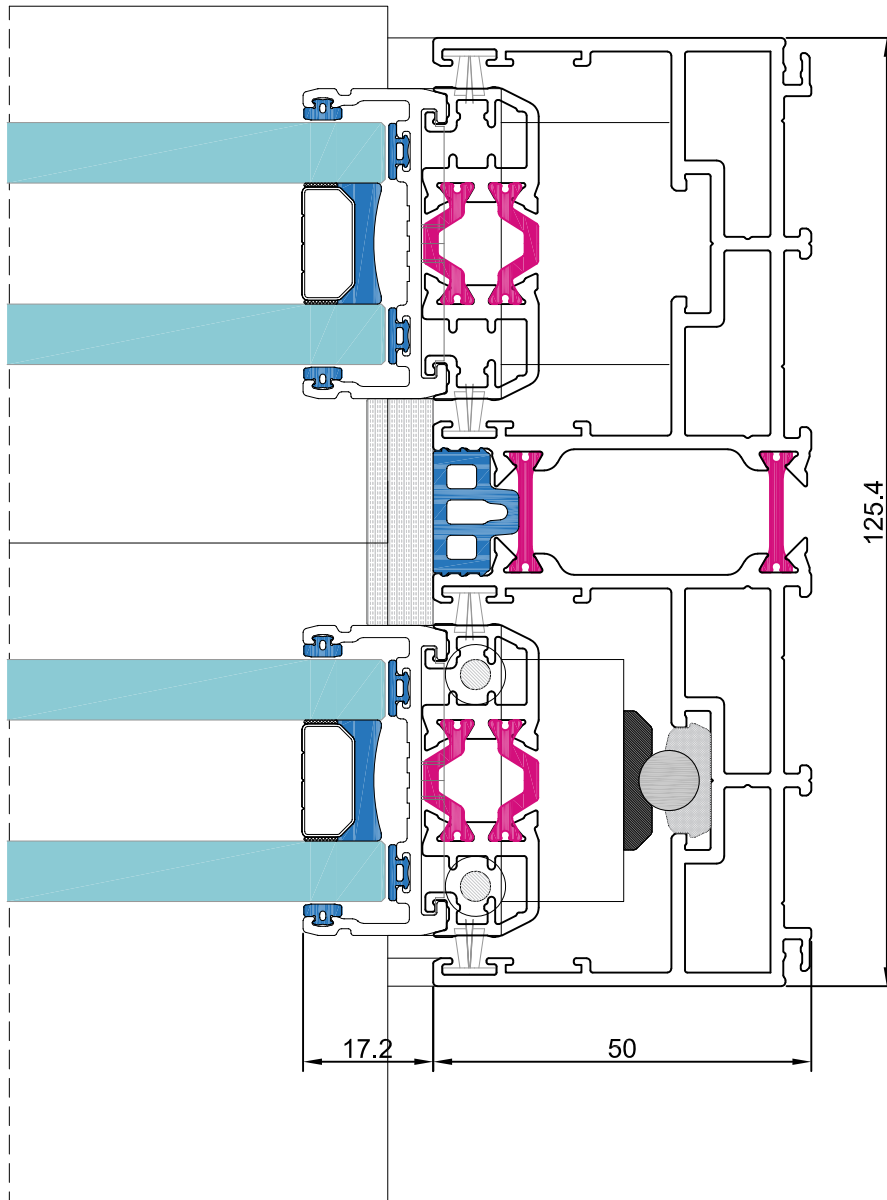

aluminio

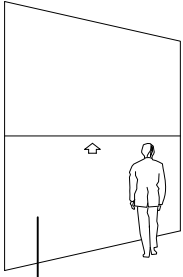

sección 3

QEXP-G GUILLOTINA

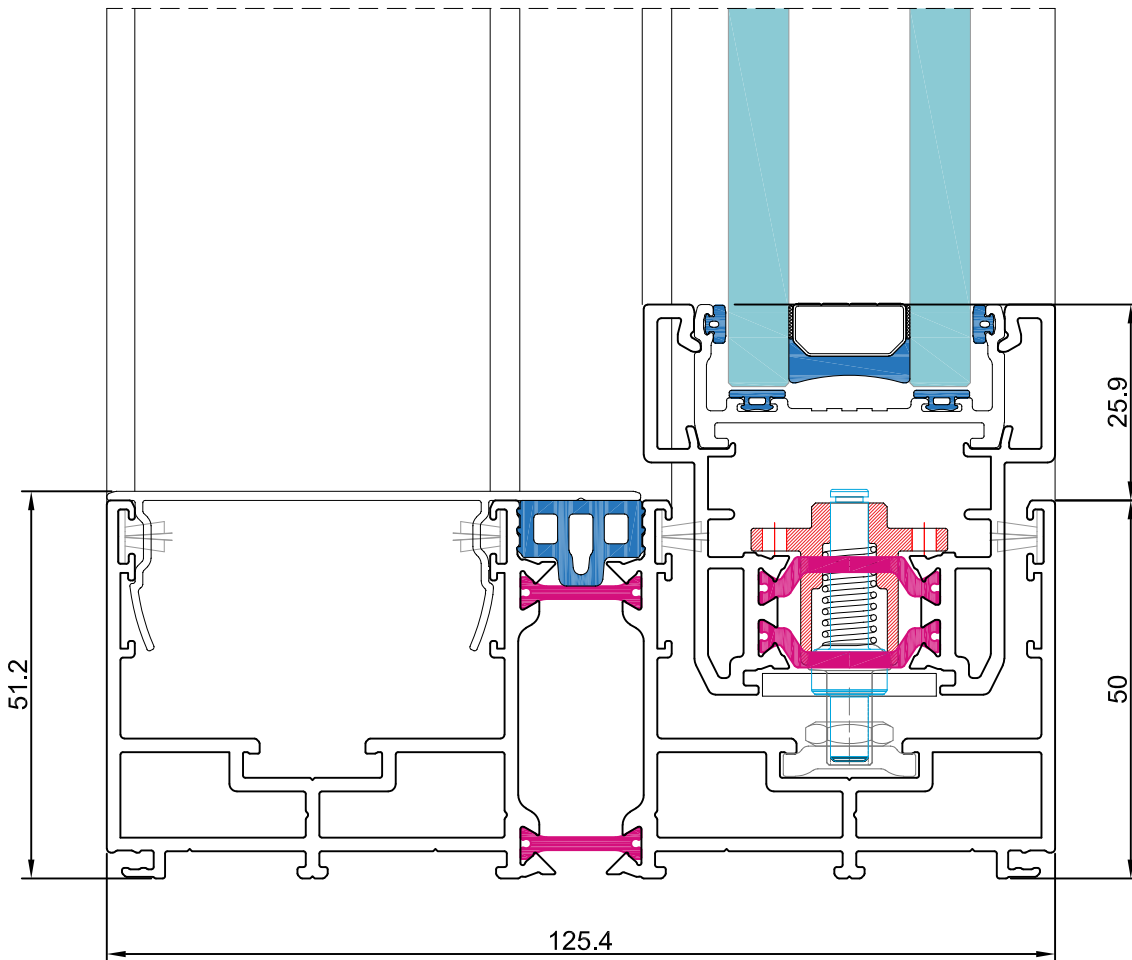

aluminio

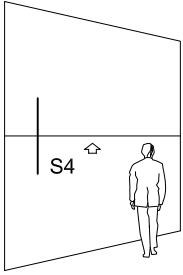

QEXP-G GUILLOTINA

sección 4

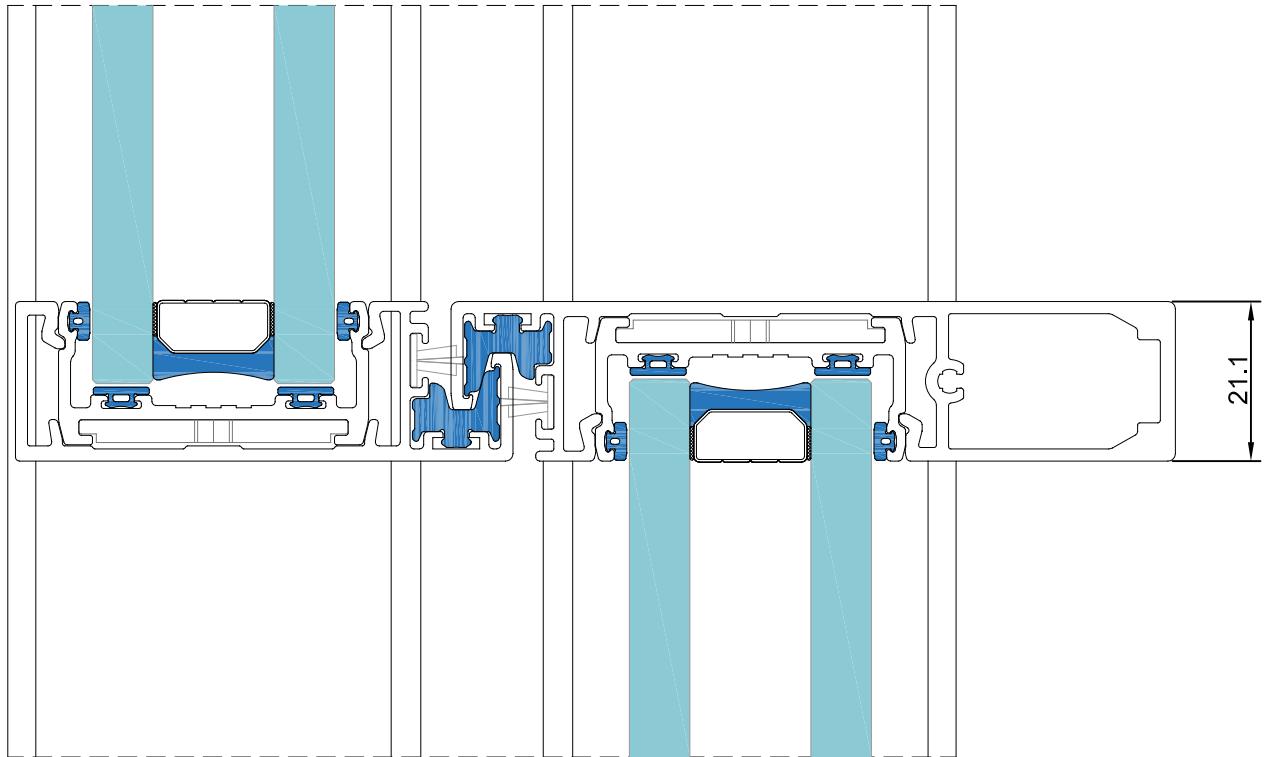

aluminio

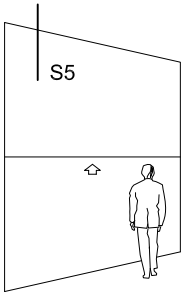

QEXP-G GUILLOTINA

sección 5

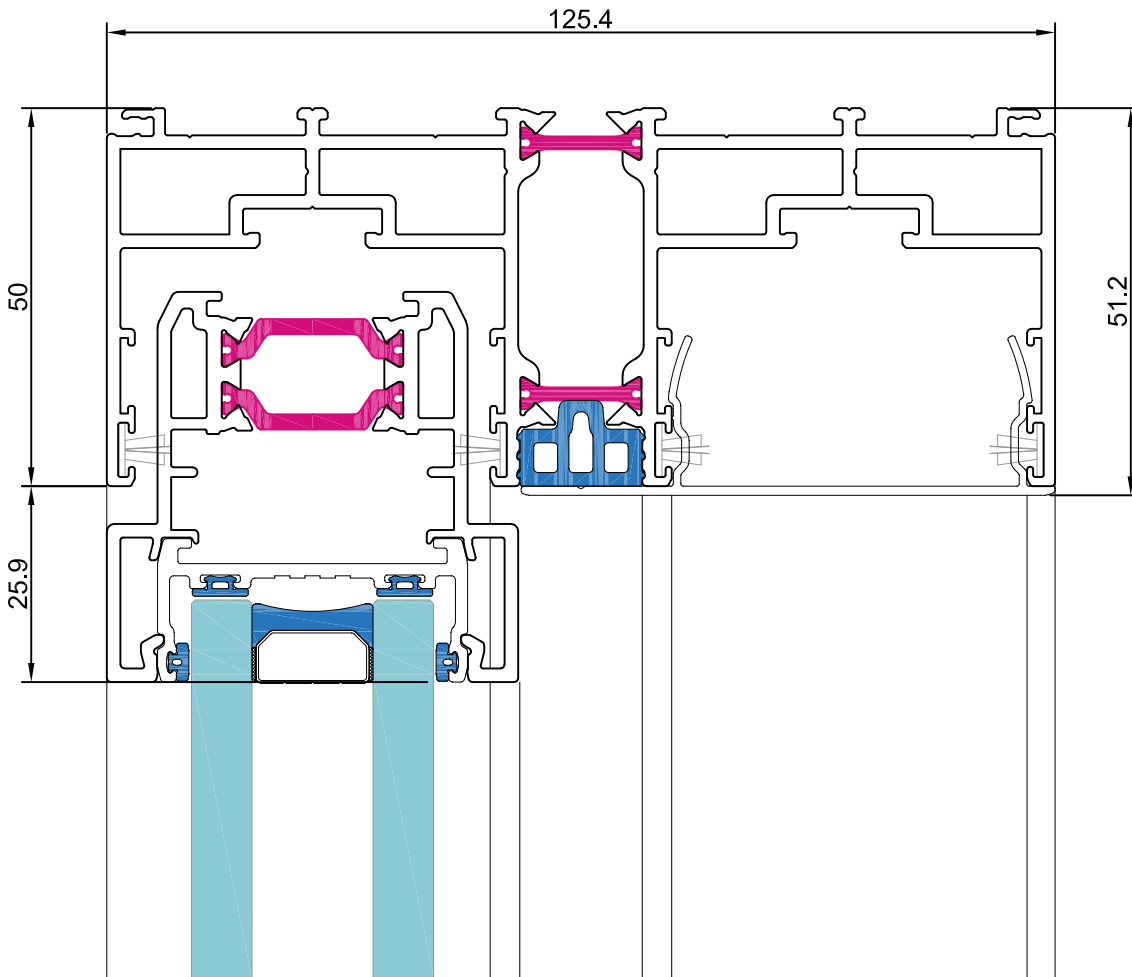

aluminio

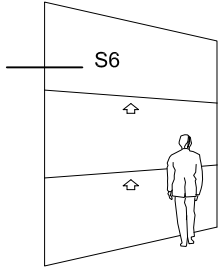

sección 6

QEXP-G GUILLOTINA

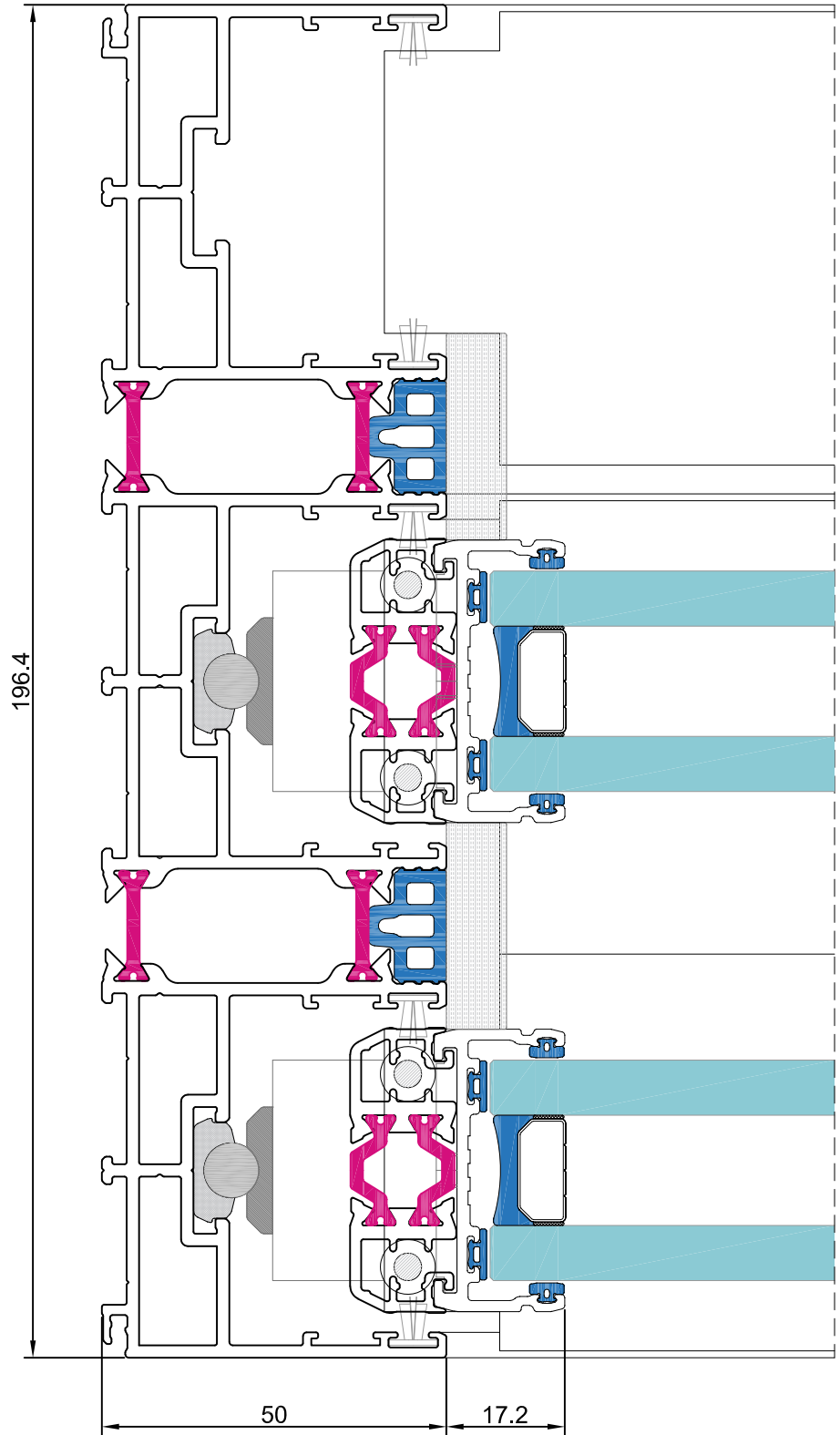

aluminio

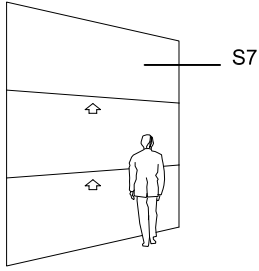

sección 7

QEXP-G GUILLOTINA

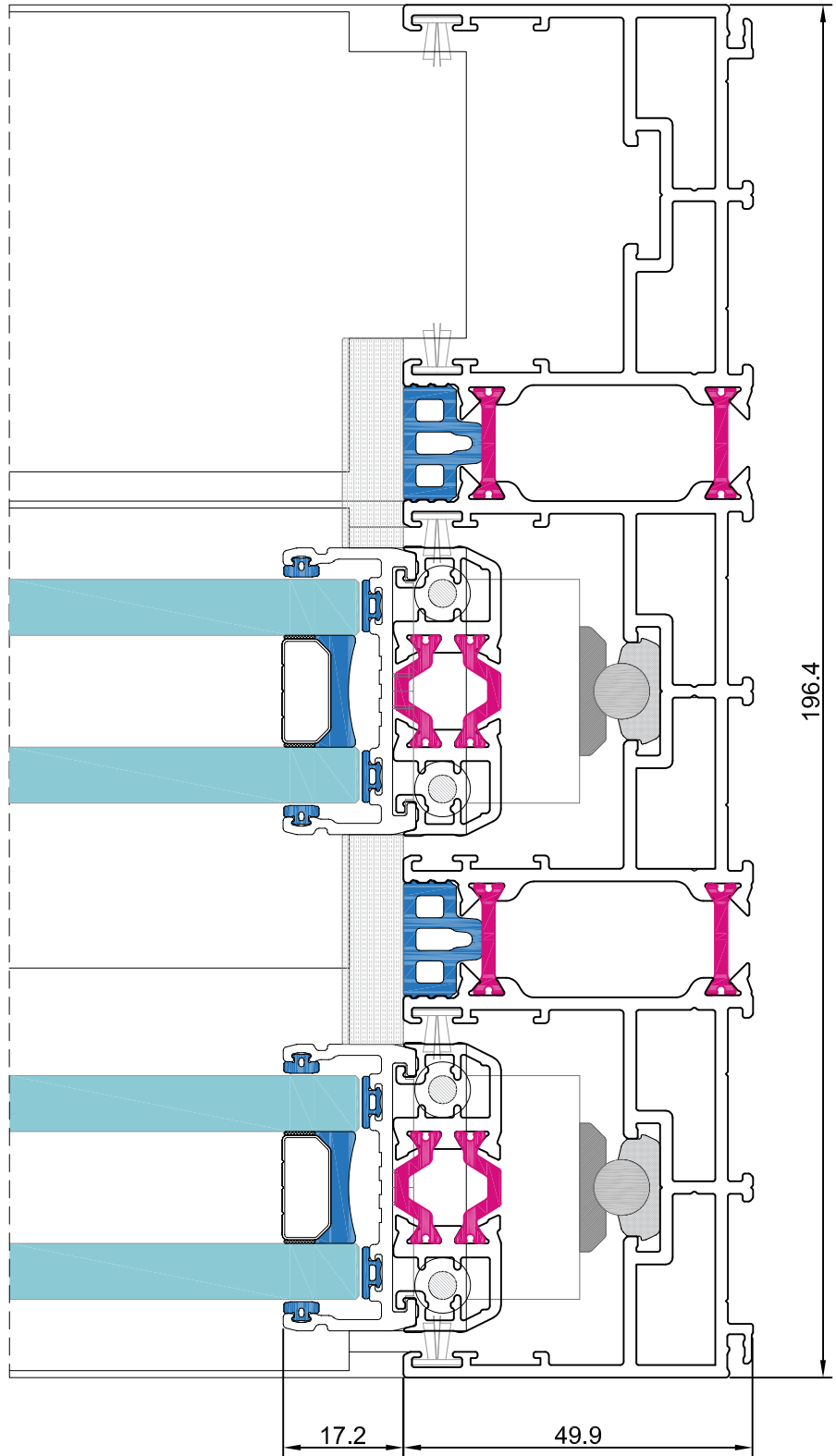

aluminio

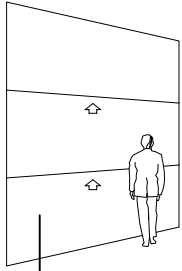

sección 8

QEXP-G GUILLOTINA

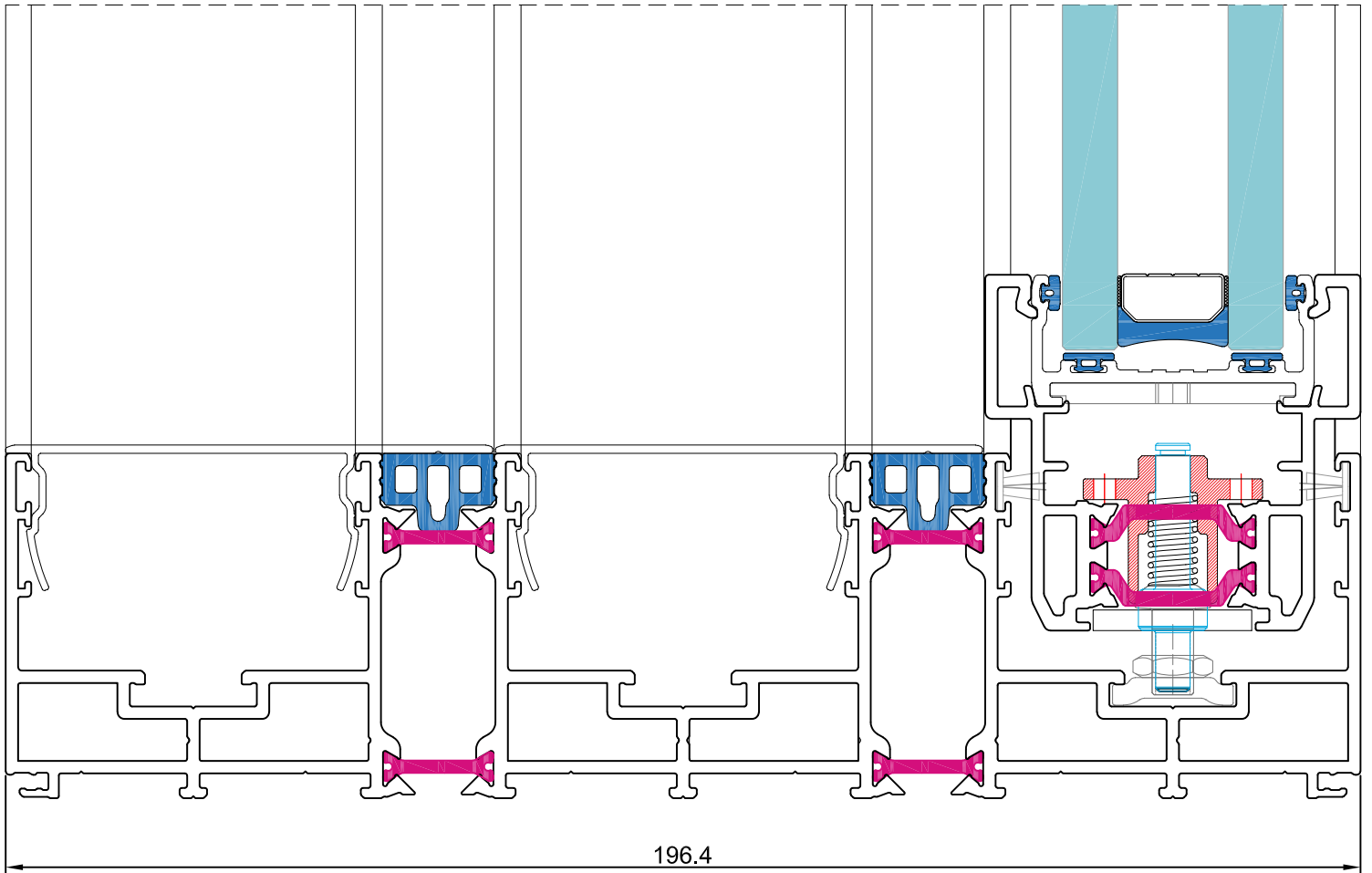

aluminio

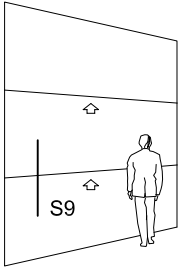

QEXP-G GUILLOTINA

sección 9

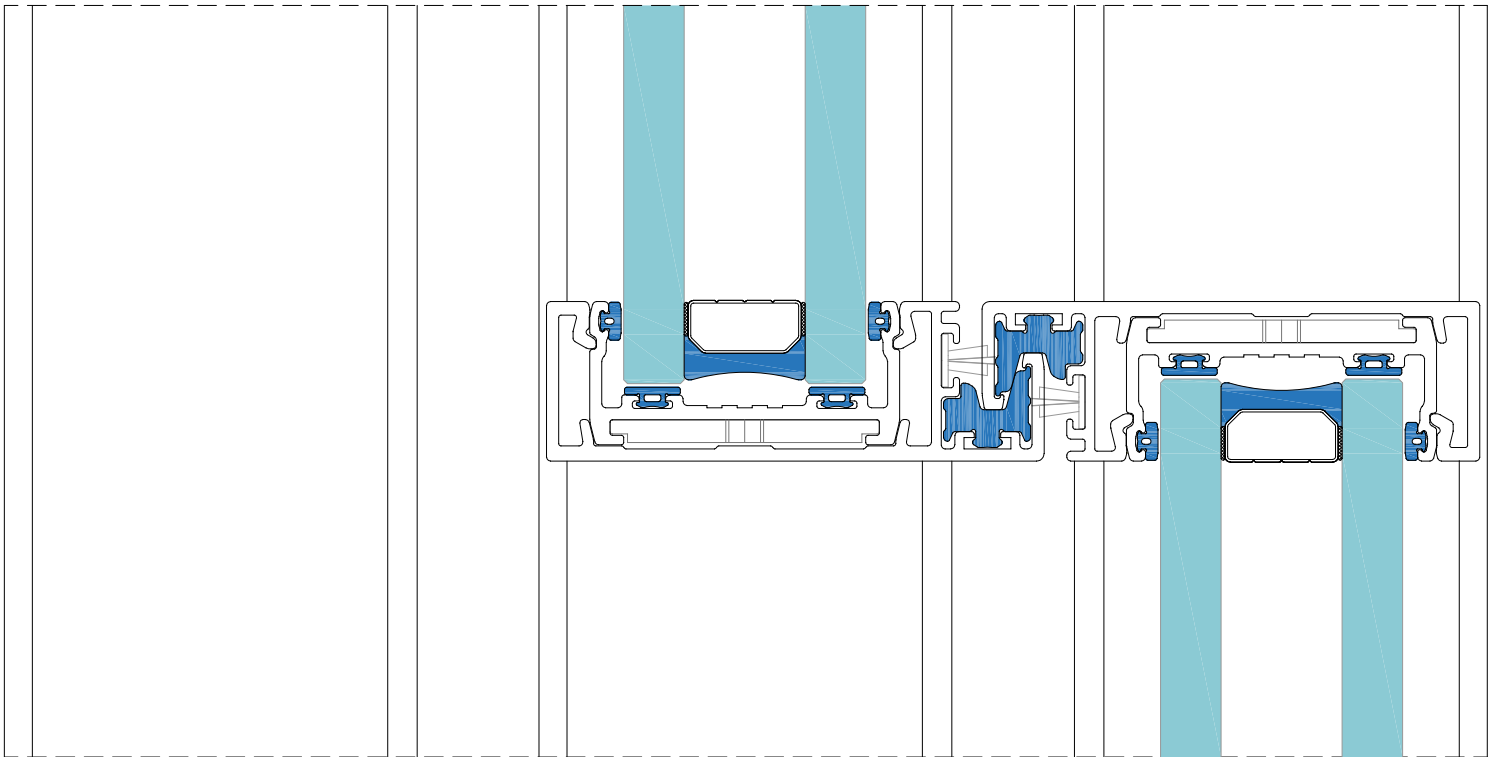

aluminio

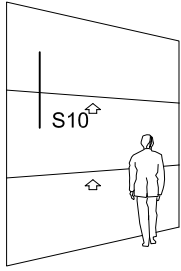

QEXP-G GUILLOTINA

sección 10

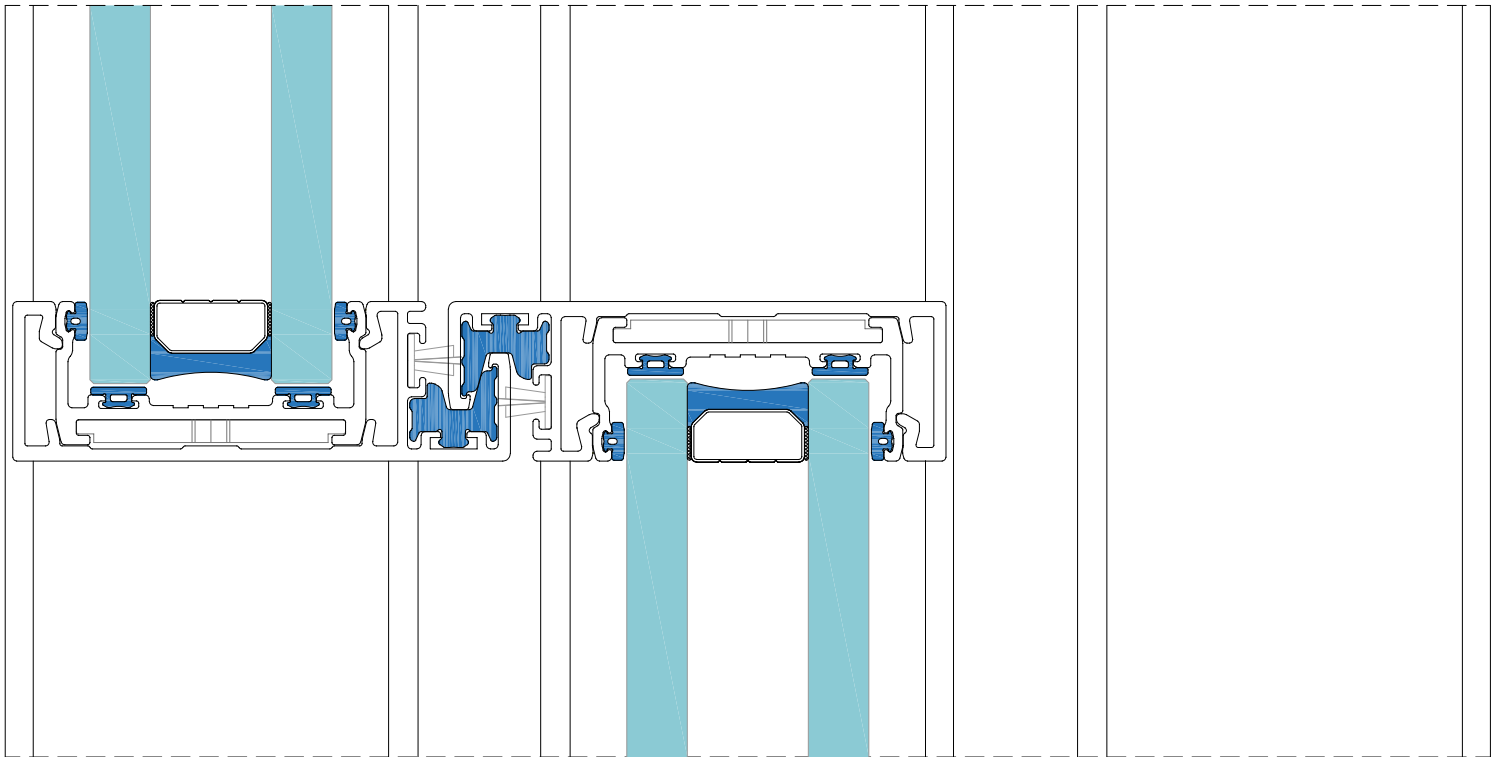

aluminio

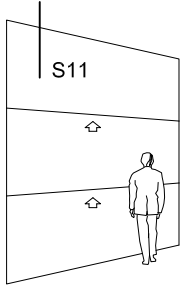

QEXP-G GUILLOTINA

sección 11

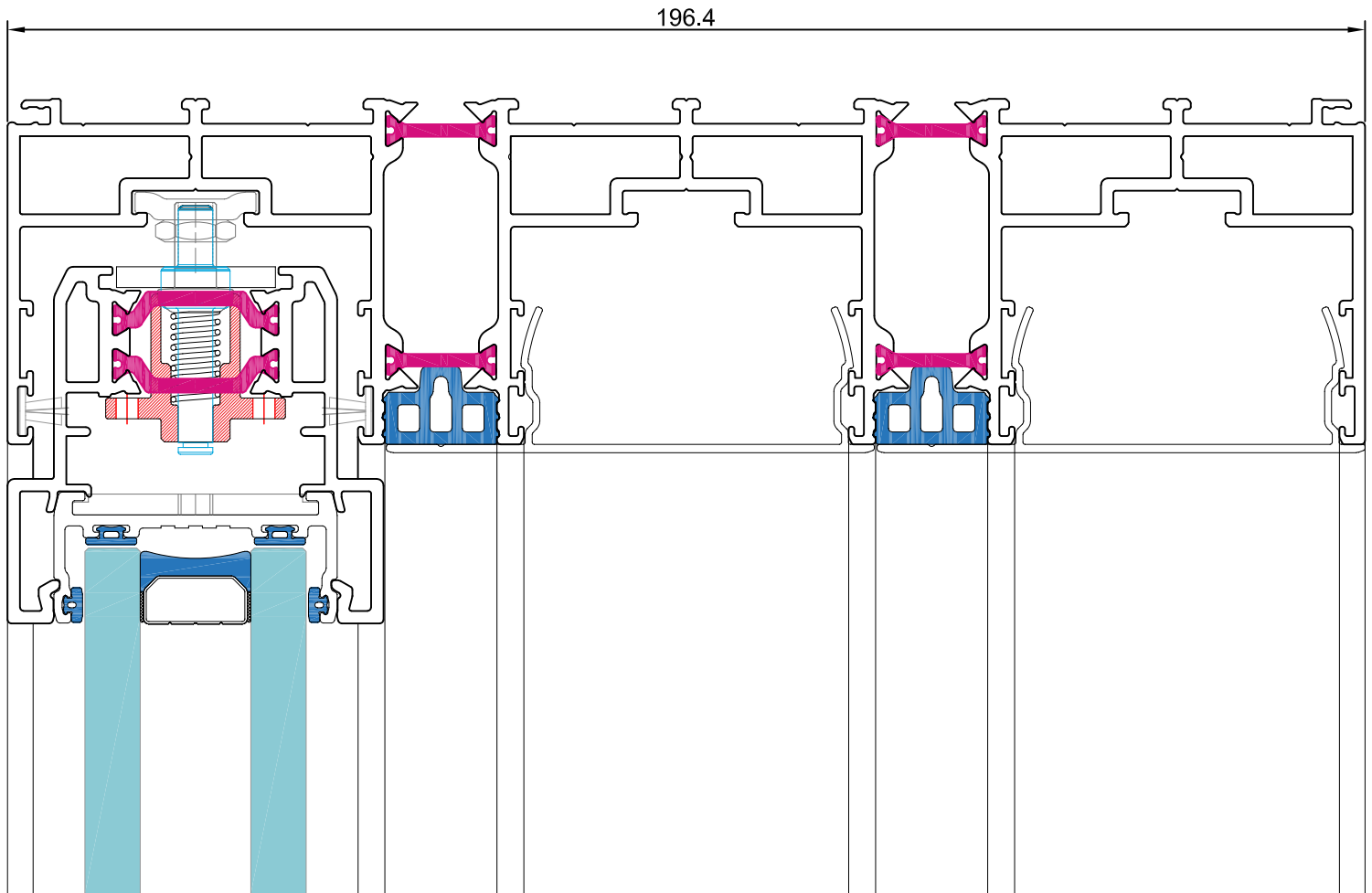

QEXP-P

PIVOT

"Imagina, nosotros lo hacemos"

En el sistema **QEXP-P PIVOT**,
existe un eje giratorio
que sostiene enormes dimensiones
y simultáneamente permite
una apertura de extrema facilidad.

Tal es la ligereza de movimientos
que abre una puerta a la imaginación.

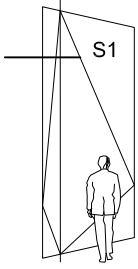

QEXP-P PIVOT

1 Hoja apertura interior

sección 1

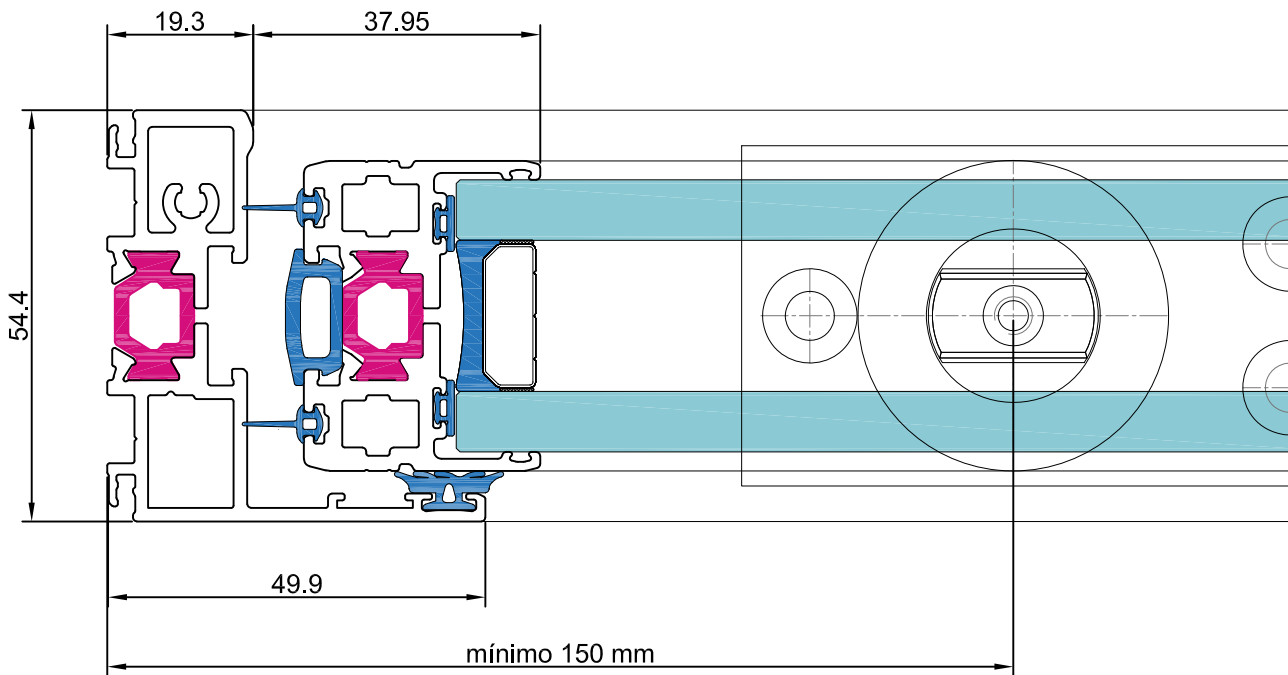

QEXP-P PIVOT

1 Hoja apertura interior

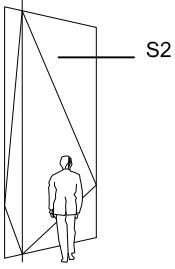

sección 2

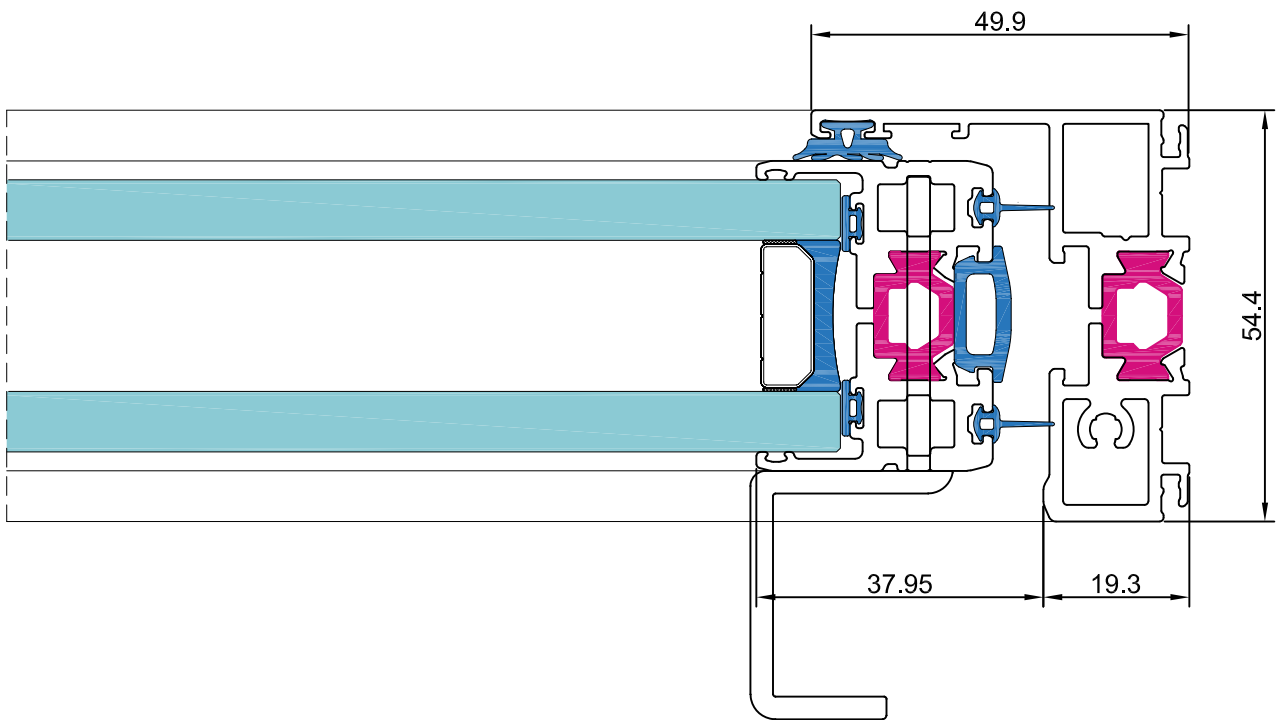

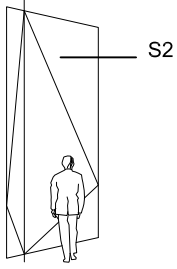

QEXP-P PIVOT

1 Hoja apertura interior
 cerradura manual/automática/eléctrica T35

sección 2

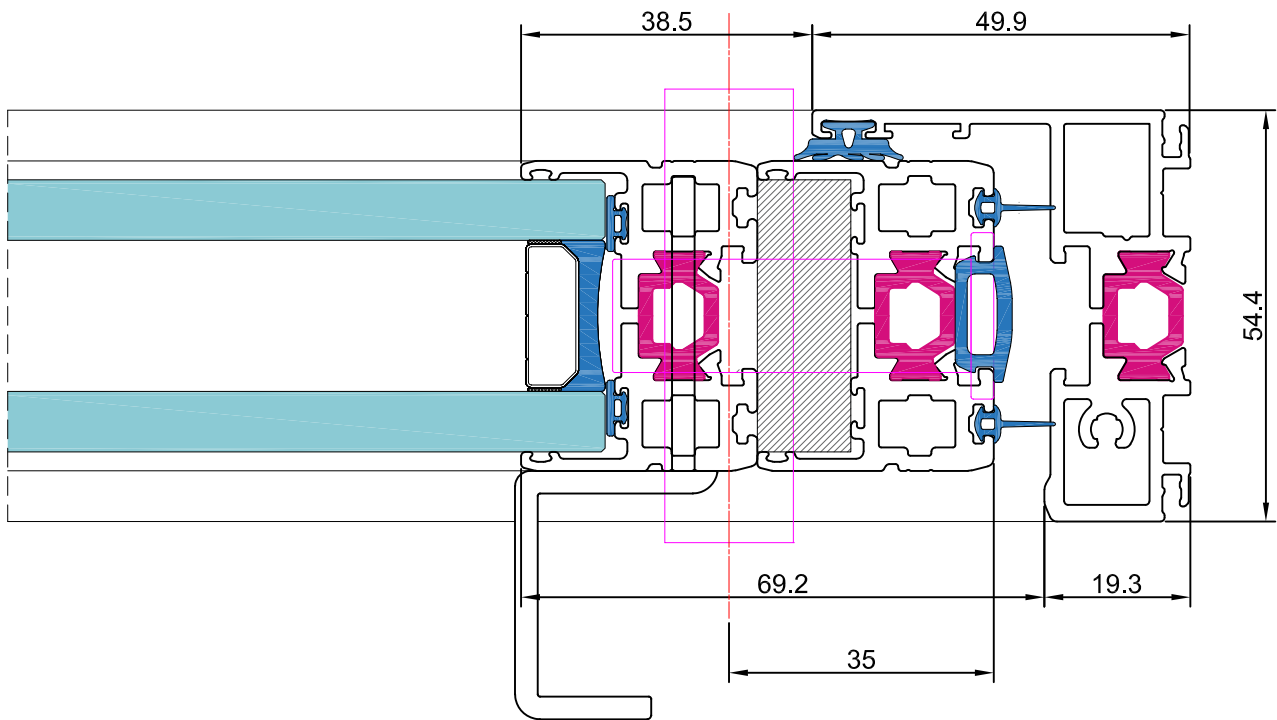



sección 3

QEXP-P PIVOT

1 Hoja apertura interior

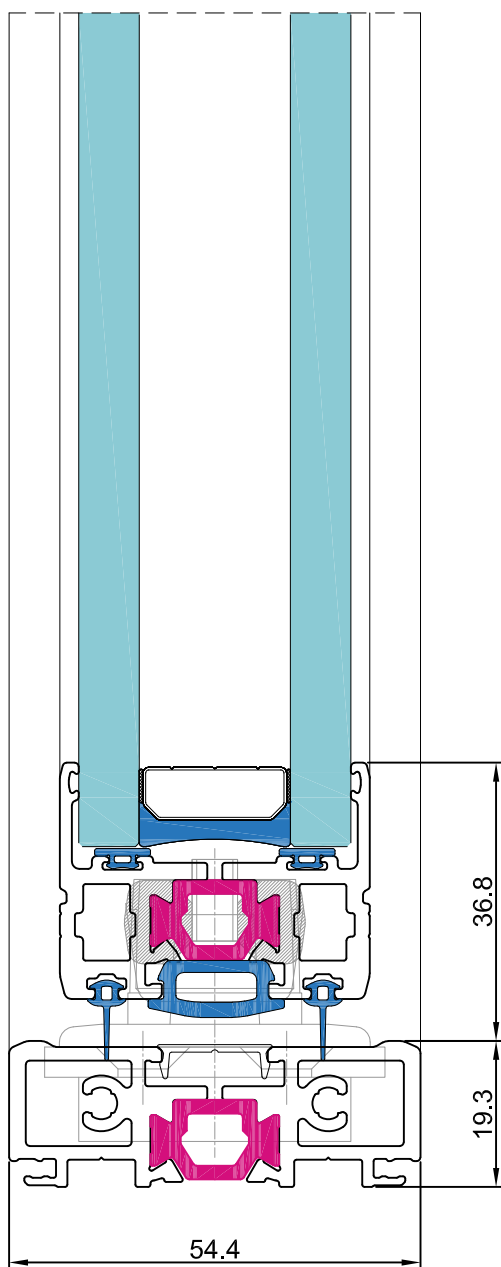

aluminio

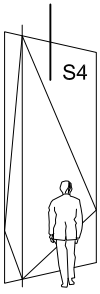

sección 4

QEXP-P PIVOT

1 Hoja apertura interior

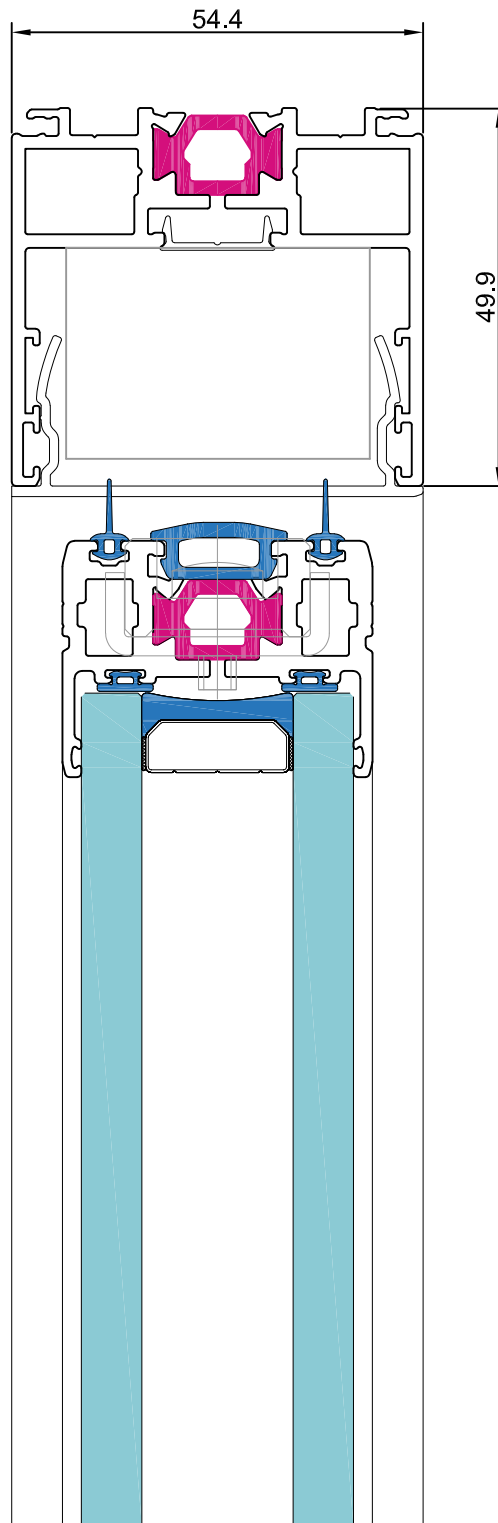

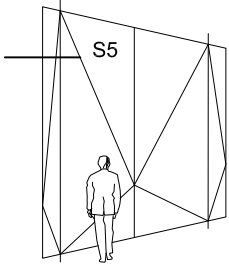

QEXP-P PIVOT

2 Hojas apertura exterior

sección 5

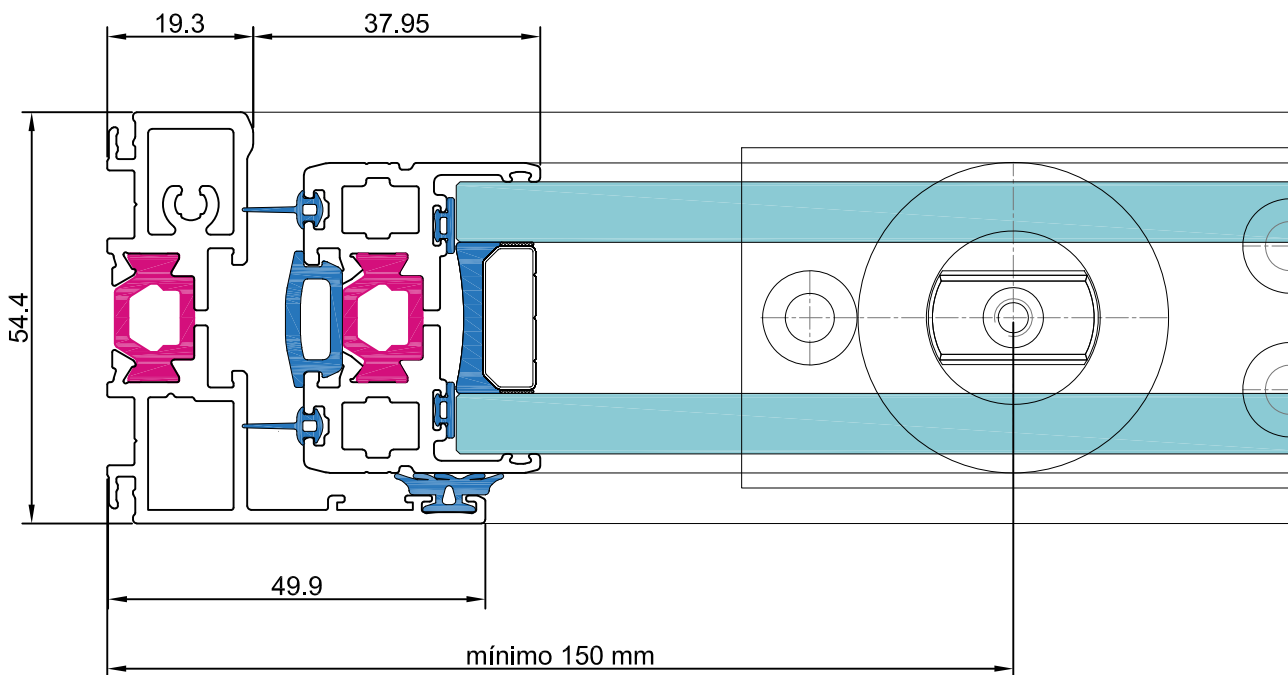

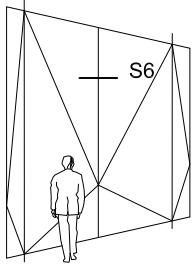

sección 6

QEXP-P PIVOT

2 Hojas apertura exterior

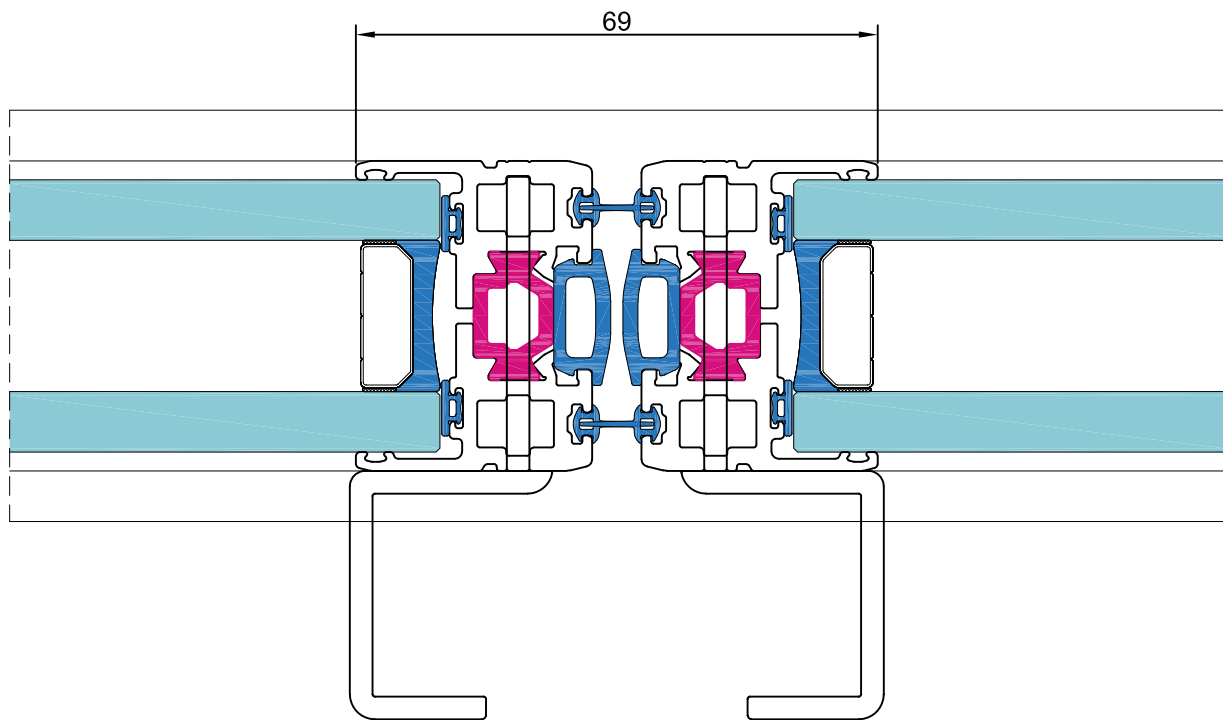

QEXP-P PIVOT

2 Hojas apertura exterior
cerradura manual/automática/eléctrica T35

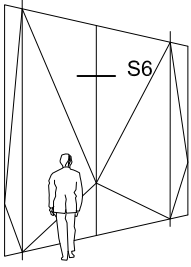

sección 6

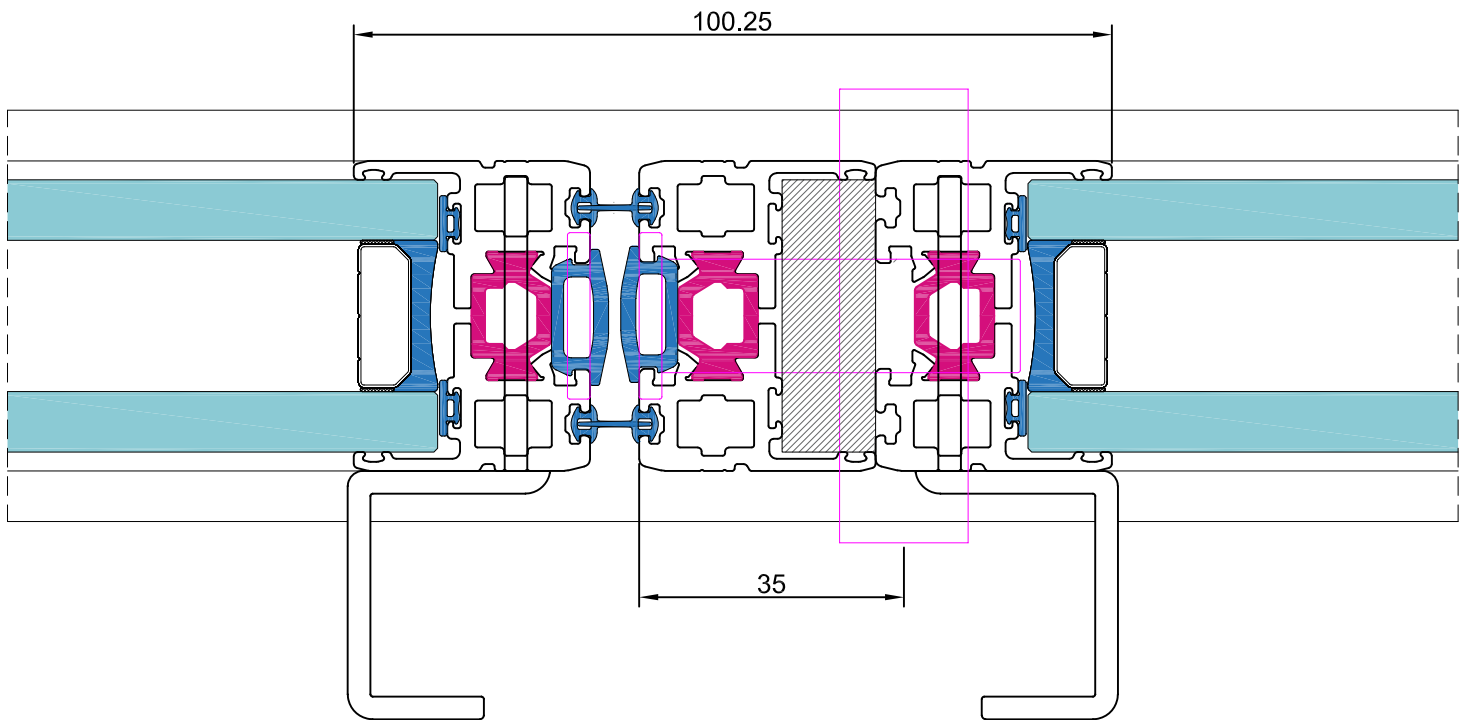

QEXP-P PIVOT

2 Hojas apertura exterior
cerradura manual/automática/eléctrica T35

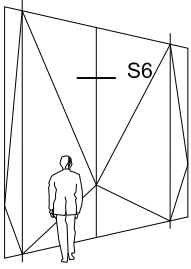

sección 6

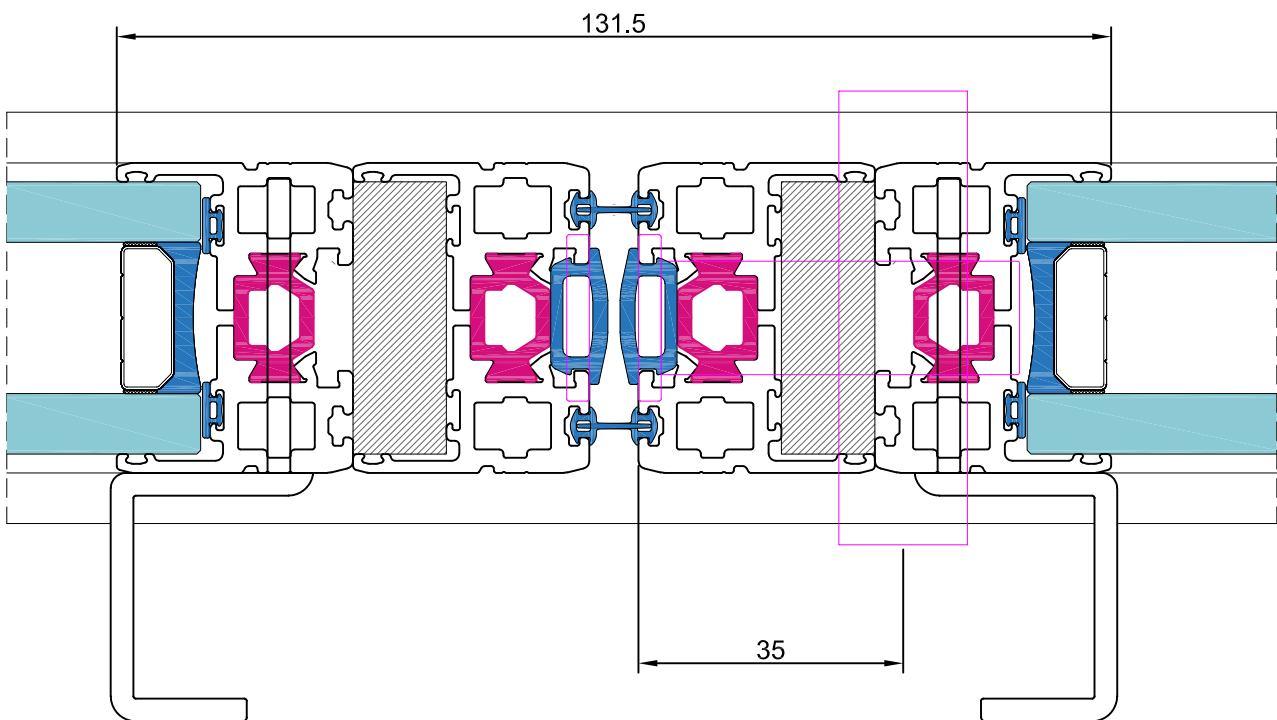

QEXP-P PIVOT

2 Hojas apertura exterior

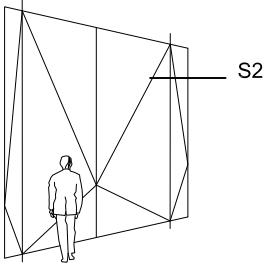

sección 7

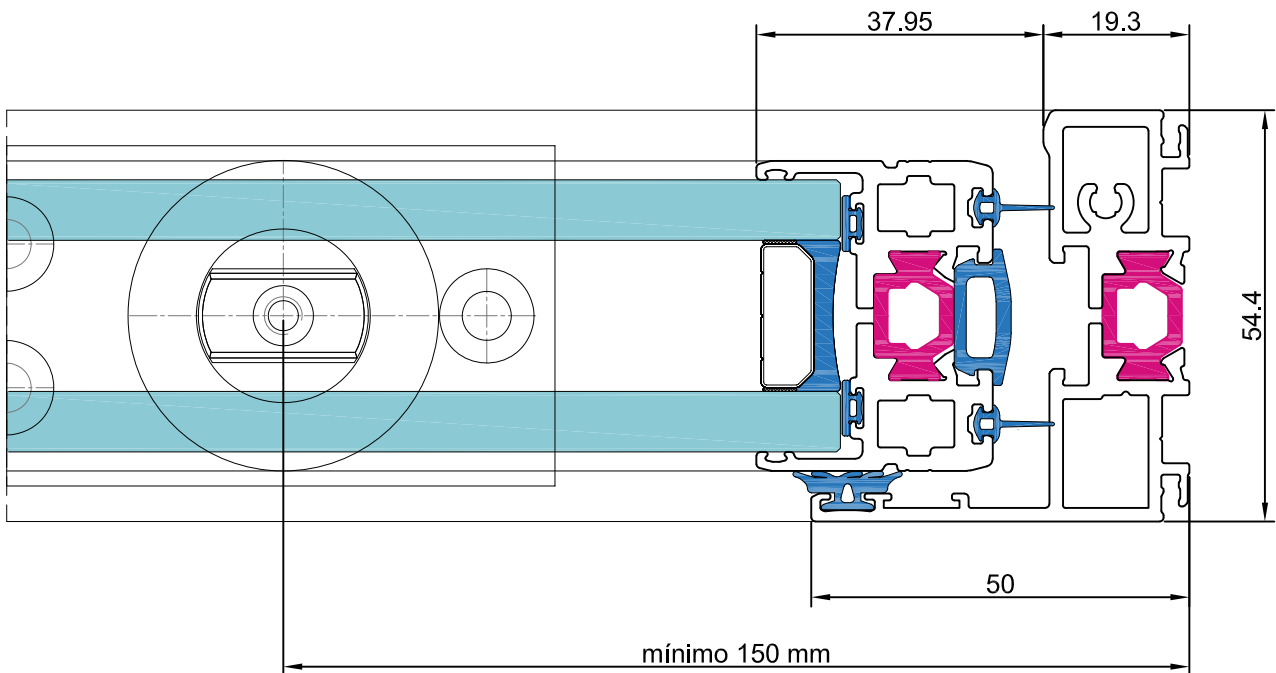

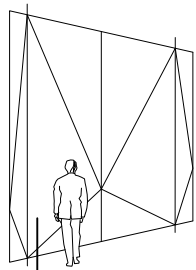

sección 8

QEXP-P PIVOT

2 Hojas apertura exterior

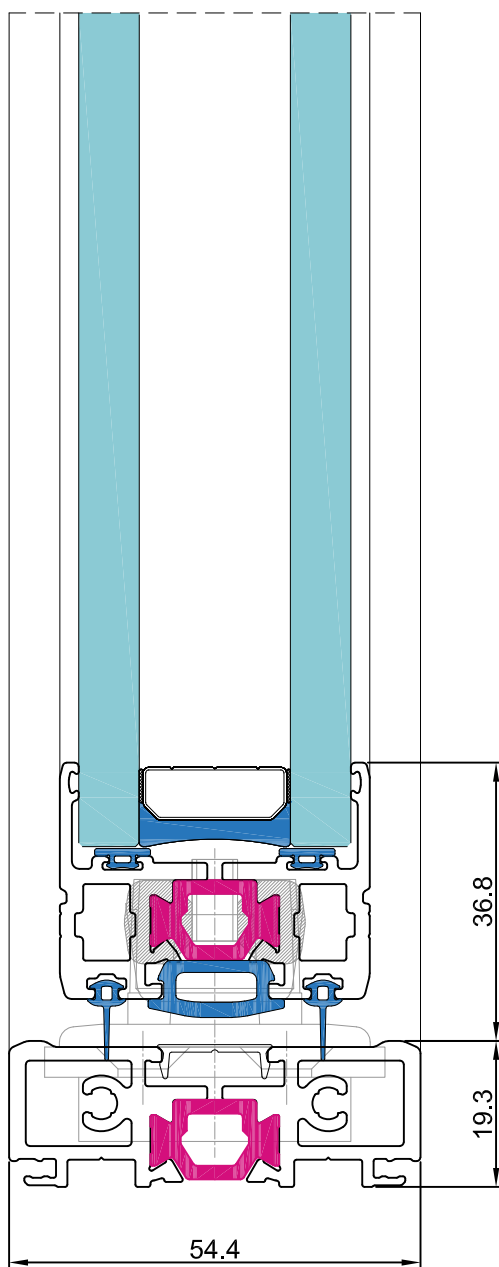

aluminio

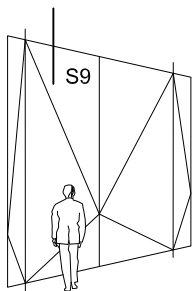

sección 9

QEXP-P PIVOT

2 Hojas apertura exterior

